

# NI 98III / NI 99III

## Handleiding

## Manual



**Mors Smitt B.V.**

Vrieslantlaan 6      3526 AA Utrecht  
P.O. box 7023      3502 KA Utrecht  
The Netherlands

T    +31 (0)30 288 13 11  
F    +31 (0)30 289 88 16  
E    sales@nieaf-smitt.nl  
I    www.nieaf-smitt.com

(c) Copyright 2013

All rights reserved. Nothing from this edition may be multiplied, or made public in any form or manner, either electronically, mechanically, by photocopying, recording, or in any manner, without prior written consent from Mors Smitt B.V. This also applies to accompanying drawings and diagrams. Due to a policy of continuous development Mors Smitt B.V. reserves the right to alter the equipment specification and description outlined in this datasheet without prior notice and no part of this publication shall be deemed to be part of any contract for the equipment unless specifically referred to as an inclusion within such contract.

## Inhoud

1	Veiligheid	4
2	Multimeter beschrijving	6
3	Voorpaneel	7
4	Functietoetsen	
	Gele functie toets	8
	Range toets	8
	Min-max toets	9
	Peak hold toets (alleen NI 99III)	10
	Smart hold toets	10
	VoltSense	11
	Verlichting	11
	Automatische uitschakeling	12
	Automatische uitschakeling uitschakelen	12
5	Werking	
	Spanningmeting	13
	Stroommeting	14
	Frequentie	15
	Weerstand / capaciteitmeting	16
	Continuïteit / diodemeting	17
	Temperatuur (alleen NI 99III)	18
6	Specificaties	
	Algemene specificaties	19
	Omgevingsomstandigheden	19
	Electrische specificaties	20
	- (1) Spanning	20
	- (2) Auto-V / LOZ	21
	- (3) Stroom	21
	- (4) Peak hold	22
	- (5) Weerstand	22
	- (6) Doorgangstest	22
	- (7) Diode test	22
	- (8) Capaciteit	23
	- (9) Frequentie	23
	- (10) Temperatuur	23
	- (11) AC+DC spanning	24
	- (12) AC+DC mV	24
	- (13) AC+DC mA	24
	- (14) AC+DC A	24
7	Onderhoud	25
	Batterij vervangen	25
	Zekering vervangen	26
8	Accessoires	27

# 1 Veiligheid

Neem de volgende voorzorgsmaatregelen door om verwonding en schade aan dit instrument of producten die erop zijn aangesloten te voorkomen. Om potentiële gevaren te voorkomen, mag u het instrument alleen op de gespecificeerde wijze gebruiken.



**LET OP:** Deze meldingen duiden op omstandigheden of handelingen die tot schade aan het instrument of aan andere zaken zouden kunnen leiden.



**WAARSCHUWING VOOR GEVAAR:** Deze meldingen duiden op omstandigheden of handelingen die tot ongevallen zouden kunnen leiden.

Symbolen op het product:



Zie de handleiding



Dubbel geïsoleerd



DC meting



AC meting



Batterij indicator



Zekering



Hoogspanning



Geeft de conformiteit met de Europese richtlijnen aan



Voer dit product alleen af volgens de lokale regelingen

## Specifieke voorzorgsmaatregelen

### **Niet gebruiken met open behuizing.**

Zet om verwonding te voorkomen, het instrument nooit onder spanning of stroom als de behuizing van het instrument niet goed dichtgeschroefd is.

### **Elektrische schokken voorkomen.**

Om ongevallen te voorkomen, mag u geen meetsnoeren aansluiten of loshalen terwijl ze zijn aangesloten op een spanningsbron.



Gebruik de multimeter alleen zoals omschreven in deze handleiding, om beschadiging van de multimeter te voorkomen



Gebruik altijd correcte aansluitingen, draaischakelaar positie en meetbereik voor het maken van een meting



Verricht nooit een spanningsmeting met een meetsnoer aangesloten op de A invoer



Controleer de werking van de multimeter door het meten van een bekende spanning. Laat bij twijfel de multimeter nakijken



Pas nooit hogere spanning toe tussen de aansluitbussen of tussen een aansluitbus en aarde, zoals aangegeven op de multimeter



Verricht geen stroommeting in een circuit met een spanning die hoger is dan de doorslagspanning van de zekering van de multimeter. Controleer vooraf met de spanningsfunctie de spanningen in het te meten circuit



Vervang defecte zekeringen met zekeringen van dezelfde waarden, zoals aangegeven in de handleiding



Wees voorzichtig bij spanningen boven 30 VAC RMS, 42 VAC peak, en 60 VDC. Deze spanningen hebben gevaar voor schokken



Vervang de batterij zodra het 'low battery' symbool in het display verschijnt, om foutieve uitlezingen te voorkomen welke tot elektrische schok en verwondingen kunnen leiden



Schakel de voeding van het circuit uit en ontlad de condensatoren met een hoge spanning voor dat men weerstand, continuïteit /doorgang, diodes of capaciteiten in dit circuit gaat meten



Gebruik de multimeter niet in de buurt van explosieve gassen of dampen



Reduceer het gevaar op elektrische schokken of brand door de multimeter niet bloot te stellen aan regen of vochtigheid

## 2 Multimeter beschrijving

De multimeter heeft veel verschillende functies en opties. De mogelijkheden worden in deze handleiding beschreven.

### Functies

- Spanning AC/DC
- Stroom AC/DC
- Frequentie
- Weerstand
- Capaciteit
- Continuïteit
- Diode
- Temperatuur °C/°F (alleen NI 99III)

### Kenmerken

- 6000 digit digitale display
- Weergave met analogoog staafdiagram, bestaand uit 62 segmenten
- Extra grote display met in/uit schakelbare heldere verlichting
- True RMS
- 0.08 % basis VDC nauwkeurigheid
- Automatische AC/DC spanning detectie met lage impedantie (Auto-V LoZ)
- VoltSense (contactloze spannings detectie)
- Smart data hold
- Peak hold (1 ms) (alleen NI 99III)
- Min - max functie
- AC+DC functie
- Frequentie
- Capaciteit meting
- Temperatuur (alleen NI 99III)
- Automatische zekeringscontrole
- Batterij indicatie
- Automatische uitschakeling (20 minuten)
- CAT IV 600 V / CAT III 1000 V
- CE markering

### 3 Voorpaneel

Bestudeer figuur 1 en de volgende genummerde stappen om uzelf bekend te maken met de bedieningsknoppen en de aansluitpunten van het voorpaneel van de meter.

1. Display
2. Functietoetsen
3. Draaischakelaar
4. A ingangsklem
5. V,  $\Omega$ , ingang
6. COM-ingang
7. mA ingang

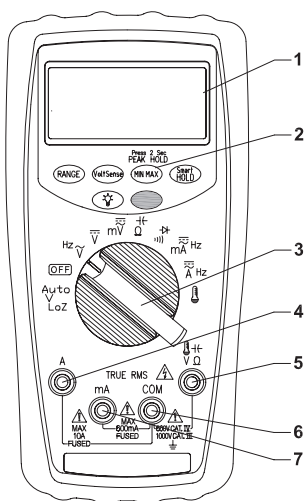

#### Uitpakken en inspectie

Nadat u uw nieuwe digitale multimeter uit de verpakking heeft gehaald, moet u over de volgende artikelen beschikken:

- 1 Digitale multimeter.
- 2 Set meetsnoeren (één zwart, één rood).
- 3 Bedieningshandleiding
- 4 Beschermende houder
- 5 Ophangmagneet
- 6 K-type temperatuur sensor (alleen NI 99III)

## 4 Functietoetsen

### Gele functie toets

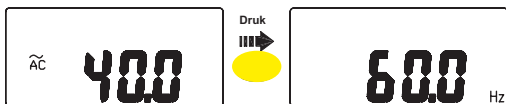

Positie schakelaar	Functie
Hz $\tilde{\sim}$	$\tilde{\sim}$ $\Rightarrow$ Hz
m $\tilde{\sim}$	m $\tilde{\sim}$ $\Rightarrow$ m $\overline{\sim}$
$\Omega$ $\text{+}$	$\Omega$ $\Rightarrow$ $\text{+}$
$\text{)))}$	$\text{)))}$ $\Rightarrow$ $\text{+}$
m $\overline{\sim}$ Hz	m $\overline{\sim}$ $\Rightarrow$ Hz $\Rightarrow$ m $\overline{\sim}$
$\overline{\sim}$ Hz	$\overline{\sim}$ $\Rightarrow$ Hz $\Rightarrow$ $\overline{\sim}$
	$^{\circ}\text{C}$ $\Rightarrow$ $^{\circ}\text{F}$

Druk op de gele functietoets om te schakelen tussen de verschillende beschikbare meetfuncties

### Range functie toets

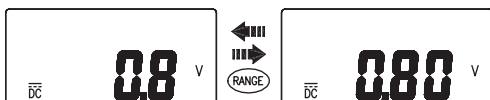

Druk **RANGE** toets om het display bereik te selecteren



## Min-max functie toets

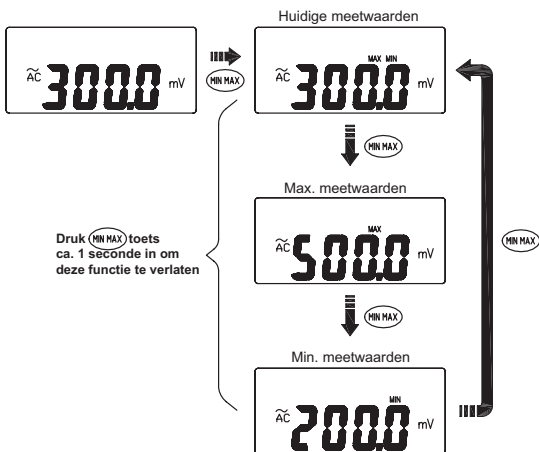

De Min-max functie monitort de minimale/maximale gemeten waarde. Middels de Min-max toets kan de minimale en maximale gemeten waarde weergegeven worden.

Door de "Min-max" toets 1 sec ingedrukt te houden wordt deze functie afgesloten.

## Peak hold functie toets (alleen NI 99III)

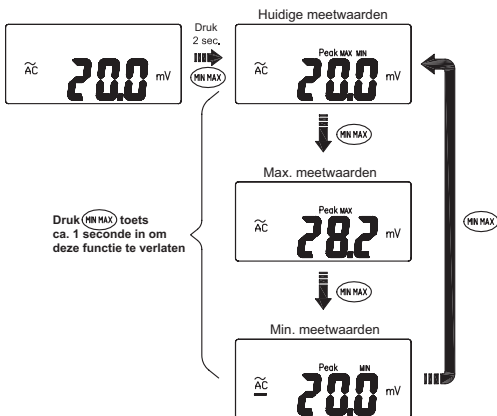

De multimeter registreert de maximum en minimum piekwaarde. Indien een nieuw minimum of maximum wordt waargenomen, wordt deze opgeslagen. Druk op de Hold toets om de meting te pauzeren.

## Smart hold functie toets

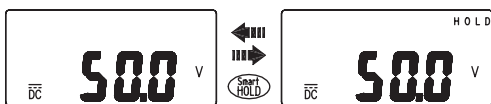

De Smart HOLD functie registreert of de gemeten meetwaarde de waarde overschrijft die op de display wordt afgebeeld. Indien deze waarde wordt overschreven klinkt een constante pieptoon. Indien de gemeten waarde lager is dan 50 digit knippert de display.

## VoltSense (contactloze spanning detectie)

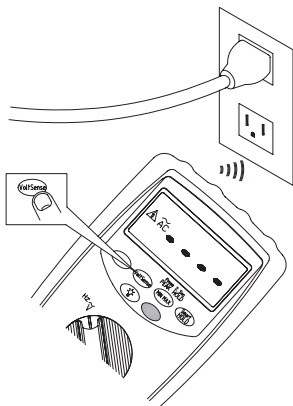

Houd de VoltSense toets ingedrukt om deze functie te gebruiken. Het aantal streepjes op de display geeft de sterkte weer van het gemeten elektrisch veld. Tevens geeft de meter een acoustisch signaal, welke naarmate de afstand tussen de gedetecteerde spanning en de bron kleiner wordt sneller klinkt.



Let op: Indien er geen indicatie wordt gegeven, is het mogelijk dat er nog steeds spanning aanwezig is! Controleer de afwezigheid van spanning altijd met een 2-polige spanningstest.

## Verlichting

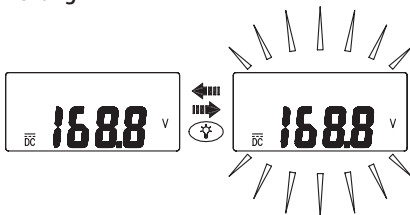

Middels de rode licht toets kan de display verlichting aan of uit geschakeld worden.

## Automatische uitschakeling

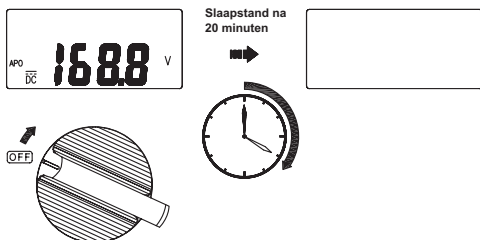

Indien de meter in slaapstand staat (auto power off) druk op een knop of draai de draaischakelaar om de meter weer te activeren.

## Automatische uitschakeling uitschakelen

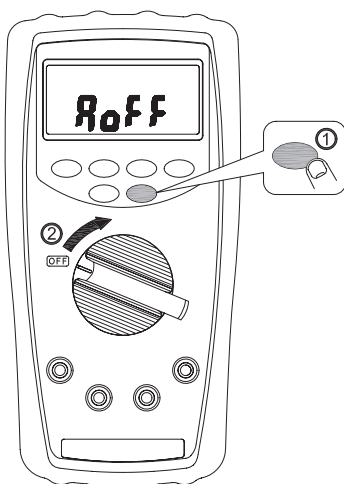

De automatische uitschakeltijd kan worden uitgeschakeld door de gele knop op de meter ingedrukt te houden en de meter aan te zetten door middel van de draaischakelaar. De melding Roff verschijnt op het display.

## 5 Werking

### Spanningmeting

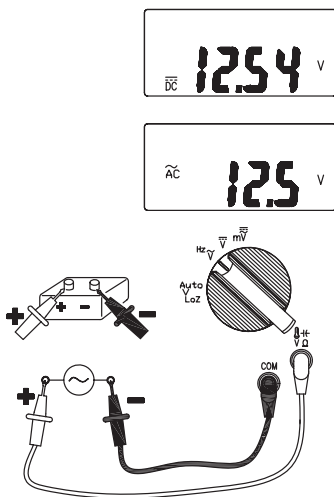

1. Sluit het rode meetsnoer aan op de 'V Ω' klem en het zwarte meetsnoer op de 'COM'-klem
2. Zet de draaischakelaar op 'V~', 'V $\overline{\text{---}}$ ' of 'mV'
3. Door middel van de gele toets is het mogelijk om de functie van de meter aan te passen, de mogelijkheden worden weer gegeven in het geel boven de stand waar de meter op staat
4. Plaats de meetsnoeren op het te meten object

## Stroommeting

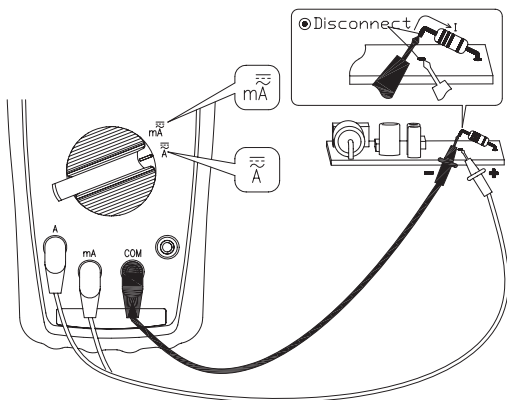

1. Sluit het rode meetsnoer aan op de 'mA'-klem en het zwarte meetsnoer op de 'COM'-klem, of gebruik de 'A'- en de 'COM'-klem in het 10 A bereik
2. Zet de draaischakelaar op "mA" of "A"
3. Standaard staat de meter ingesteld op het meten van AC, met de gele toets kan er gekozen voor een DC of AC+DC meting. Op het display van de multimeter wordt er aangeduid in welke stand de meter staat.
4. Plaats de meetsnoeren op het te meten object

## Frequentie

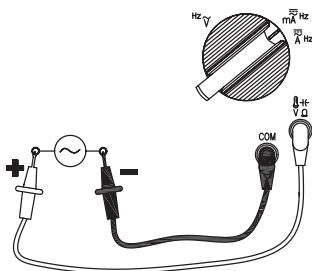

1. Sluit het rode meetsnoer aan op de 'V Ω' klem en het zwarte meetsnoer op de 'COM'-klem
2. Zet de draaischakelaar op de 'V~/Hz' stand
3. Druk eenmaal op de gele toets om de meter in Hz stand te zetten
4. Plaats de meetsnoeren op het te meten object

## Weerstand / capaciteit meting

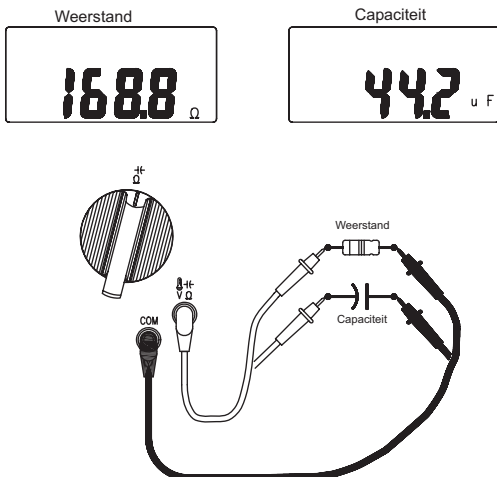

1. Sluit het rode meetsnoer aan op de '  $\Omega$  ' klem en het zwarte meetsnoer op de 'COM'-klem
2. Zet de draaischakelaar op de 'Ω' stand
3. Met de gele toets kan de functie van de meter worden aangepast van 'Ω' naar 'uF' en terug
4. Plaats de meetsnoeren op het te meten object



## Continuïteit / diode meting

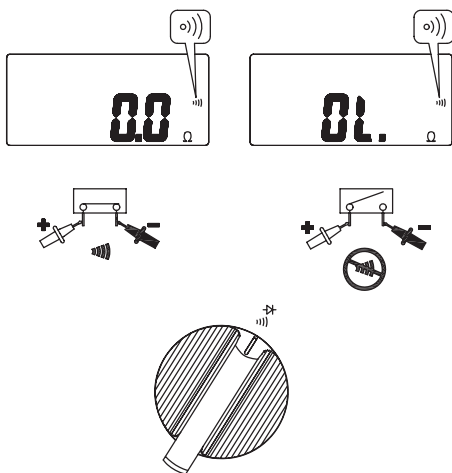

1. Sluit het rode meetsnoer aan op de 'V  $\Omega$ '-klem en het zwarte meetsnoer op de 'COM'-klem
2. Zet de draaischakelaar op de 'o)))  $\rightarrow$   $\rightarrow$ ' stand
3. Met de gele toets kan de functie van de meter worden aangepast van een continuïteit meting 'o)))' naar een diode meting ' $\rightarrow$   $\rightarrow$ ' en weer terug.
4. Plaats de meetsnoeren op het te meten object

## Temperatuur °C / °F meting (alleen NI 99III)

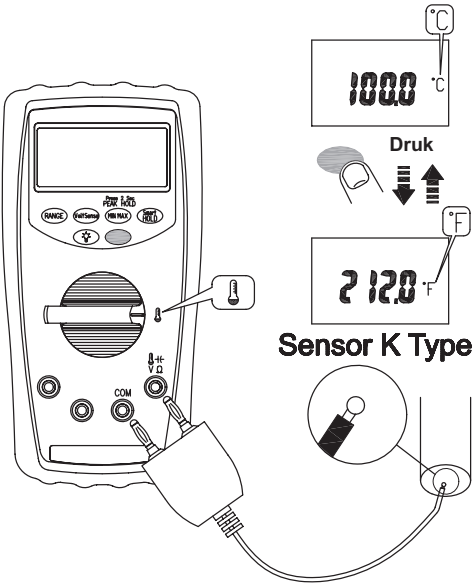

1. Sluit de + van de sensor adapter aan op de 'V Ω' klem en de andere op de 'COM' klem
2. Zet de draaischakelaar op de 'F' stand
3. Met de gele toets kan de functie van de meter worden aangepast van een °C' naar een °F' meting en weer terug

## 6 Specificaties

### Algemene specificaties

Weergave	LCD, 6000 digit
Polariteitsindicatie	Automatisch, negatief wordt aangeduid
Buiten bereik indicatie	OL
Stroomvereisten	9 V batterij
Batterij indicatie	Knippert indien de batterijspanning onder de werkspanning komt
Levensduur batterij	Alkaline 150 uur (bij gebruik zonder LCD verlichting)
Automatische uitschakeling	Na 20 minuten
Werktemperatuur	-10 °C...10 °C 10 °C...30 °C, vochtigheidsgraad tot 80 % 30 °C...40 °C, vochtigheidsgraad tot 75 % 40 °C...50 °C, vochtigheidsgraad tot 45%
Opslagtemperatuur	-20 °C...60 °C, vochtigheidsgraad 0 tot 80 % als de batterij uit de meter wordt verwijderd
Temperatuur-coëfficiënt	0.15 x (gespecificeerde nauwkeurigheid) / °C, < 18 °C of > 28 °C
Gewicht	460 g (incl. batterijen)
Afmetingen (lxhxd)	94 x 190 x 48 mm, incl. holster
Accessoires	Beschermholster, batterijen, meetsnoeren, ophangmagneet, thermokoppel (alleen NI 99III) en handleiding

### Omgevingsomstandigheden

Maximum hoogte	2000 meter
Installatiecategorie	Voldoet aan EN 61010-1, UL 61010-1, IEC 1010-1, CAT IV 600 V, CAT III 1000 V
EMC	EN 61326-1
Vervuilingsgraad	2

## Electrische specificaties

Nauwkeurigheid is  $\pm$  (% uitlezing + aantal digits) bij 23 °C  $\pm$  5 °C, bij een vochtigheidsgraad van minder dan 80 %.

### (1) Spanning

Bereik	Resolutie	Nauwkeurigheid NI 98III	Nauwkeurigheid NI 99III
60.00 m VDC	0.01 mV	-	$\pm$ (0.08 % + 10 d)
600.0 m VDC	0.1 mV	$\pm$ (0.1 % + 2 d)	$\pm$ (0.08 % + 2 d)
6.000 VDC	0.001 V	$\pm$ (0.09 % + 2 d)	$\pm$ (0.08 % + 2 d)
60.00 VDC	0.01 V	$\pm$ (0.09 % + 2 d)	$\pm$ (0.08 % + 2 d)
600.0 VDC	0.1 V	$\pm$ (0.09 % + 2 d)	$\pm$ (0.08 % + 2 d)
1000 VDC	1 V	$\pm$ (0.09 % + 2 d)	$\pm$ (0.08 % + 2 d)
60.0 m VAC	0.1 mV	-	$\pm$ (1.20 % + 5 d)
600.0 m VAC	0.1 mV	$\pm$ (1.5 % + 5 d)	$\pm$ (1.20 % + 5 d)
6.000 VAC	0.001 V	$\pm$ (1.0 % + 3 d)	$\pm$ (0.80 % + 5 d)
60.00 VAC	0.01 V	$\pm$ (1.0 % + 3 d)	$\pm$ (0.80 % + 5 d)
600.0 VAC	0.1 V	$\pm$ (1.0 % + 3 d)	$\pm$ (0.80 % + 5 d)
1000 VAC	1 V	$\pm$ (1.0 % + 3 d)	$\pm$ (0.80 % + 5 d)

Bescherming tegen overbelasting	1000 VAC/DC RMS
AC frequency	50 Hz ~ 1 KHz
Ingangsimpedantie	10 M $\Omega$ , < 100 pF
Wisselstroom omvormingstype	Wisselstroomomvormingen zijn gekoppeld aan de wisselstroom, reageren op de werkelijke RMS waarde, gekalibreerd op de RMS waarde van de sinusgolf
Crest factor	1.4 tot 2.0, voeg 1.0 % toe aan de nauwkeurigheid 2.0 tot 2.5, voeg 2.5 % toe aan de nauwkeurigheid 2.5 tot 3.0, voeg 4.0 % toe aan de nauwkeurigheid

## (2) Auto-V (automatische spanning selectie)

Bereik	Resolutie	Nauwkeurigheid NI 98III	Nauwkeurigheid NI 99III
600.0 VDC	0.1 V		
1000 VDC	1 V		
600.0 VAC	0.1 V	$\pm (1.0 \% + 3 \text{ d})$	$\pm (0.80 \% + 3 \text{ d})$
1000 VAC	1 V		

Bescherming tegen overbelasting	1000 VAC/DC RMS
AC frequency	50 Hz ~ 1 KHz
Ingangsimpedantie	$\pm 3 \text{ k}\Omega$
Wisselstroom omvormingstype	Wisselstroomomvormingen zijn gekoppeld aan de wisselstroom, reageren op de werkelijke RMS waarde, gekalibreerd op de RMS waarde van de sinusgolf

## (3) Stroom

Bereik	Resolutie	Nauwkeurigheid NI 98III	Nauwkeurigheid NI 99III
60.00 m ADC	0.01 mA	$\pm (0.1 \% + 3 \text{ d})$	$\pm (0.8 \% + 3 \text{ d})$
600.0 m ADC	0.1 mA	$\pm (0.1 \% + 3 \text{ d})$	$\pm (0.8 \% + 3 \text{ d})$
6.000 ADC	0.001 A	$\pm (0.1 \% + 3 \text{ d})$	$\pm (0.8 \% + 3 \text{ d})$
10.00 VDC	0.01 A	$\pm (0.1 \% + 3 \text{ d})$	$\pm (0.8 \% + 3 \text{ d})$
60.00 m AAC	0.01 mA	$\pm (1.5 \% + 3 \text{ d})$	$\pm (1.2 \% + 3 \text{ d})$
600.0 mAAC	0.1 mA	$\pm (1.5 \% + 3 \text{ d})$	$\pm (1.2 \% + 3 \text{ d})$
6.000 AAC	0.001 A	$\pm (1.5 \% + 3 \text{ d})$	$\pm (1.2 \% + 3 \text{ d})$
10.00 AAC	0.01 A	$\pm (1.5 \% + 3 \text{ d})$	$\pm (1.2 \% + 3 \text{ d})$

Zekering	Voorzien van hoogspanningszekering 440 mA, 1000 VAC/DC 10 KA zekering voor mA ingang 11 A, 1000 VAC/DC 20 KA zekering voor A ingang
Max. meettijd	3 minuten voor A ingang 10 minuten voor mA ingang Rusttijd na max. meettijd bedraagt 20 minuten
AC frequency	50 Hz ~ 1 KHz
Wisselstroom omvormingstype	Omvormingstype en specificaties zijn identiek aan de spanning functie

#### (4) Peak hold (alleen NI 99III)

Nauwkeurigheid ca 150 d

#### (5) Weerstand

Bereik	Resolutie	Nauwkeurigheid
600.0 $\Omega$	0.1 $\Omega$	$\pm (0.8 \% + 5 \text{ d})$
6000.0 K $\Omega$	0.001 K $\Omega$	
60.00 K $\Omega$	0.01 K $\Omega$	$\pm (0.8 \% + 5 \text{ d})$
600.0 K $\Omega$	0.1 K $\Omega$	
6.000 M $\Omega$	0.001 M $\Omega$	
40.00 M $\Omega$	0.01 M $\Omega$	$\pm (1.0 \% + 5 \text{ d}) < 10 \text{ M}\Omega$ $\pm (1.0 \% + 5 \text{ d}) > 10 \text{ M}\Omega$

Bescherming tegen overbelasting	1000 VAC/DC RMS
Open klemspanning	Ca. 2.5 V voor 600 $\Omega$ & 6 k $\Omega$ bereik
Max. teststroom	Ca. 0.1 mA

#### (6) Doorgangstest

Bereik	Resolutie	Nauwkeurigheid
600.0 $\Omega$	0.1 $\Omega$	$\pm (0.8 \% + 5 \text{ d})$

Bescherming tegen overbelasting	1000 VAC/DC RMS
Open klemspanning	Ca. 2.5 V
Max. teststroom	Ca. 0.1 mA
Drempel van geleidend vermogen	< 30 $\Omega$ beep aan < 100 $\Omega$ beep uit
Indicator van geleidend vermogen	2.7 KHz geluidsignaal

#### (7) Diode test

Bereik	Resolutie	Nauwkeurigheid
2.000 V	1 mA	$\pm (1.5 \% + 2 \text{ d})$

Bescherming tegen overbelasting	1000 VAC/DC RMS
Open klemspanning	Ca. 2.5 V
Max. teststroom	Ca. 0.4 mA

## (8) Capaciteit

Bereik	Resolutie	Nauwkeurigheid
1.000 $\mu$ F	0.001 $\mu$ F	$\pm (1.2 \% + 2 \text{ d})$
10.00 $\mu$ F	0.01 $\mu$ F	
100.0 $\mu$ F	0.1 $\mu$ F	
1.000 mF	0.001 mF	
10.00 mF	0.01 mF	

Bescherming tegen overbelasting	1000 VAC/DC RMS
Max. meettijd	0.7 sec voor 1 nF ~ 1 mF 3 sec voor 1 mF ~ 10 mF

## (9) Frequentie

Bereik	Resolutie	Nauwkeurigheid
100.00 Hz	0.01 Hz	$\pm (0.1 \% + 2 \text{ d})$
1000.0 Hz	0.1 Hz	
10.000 KHz	0.001 KHz	
100.00 KHz	0.01 KHz	

Bescherming tegen overbelasting	1000 VAC/DC RMS
Min. frequency	1 Hz
Gevoeligheid	> 5.0 VDC (voor ACV 1 Hz ~ 10 kHz) > 10 V <sub>p-p</sub> (voor ACV 10 kHz ~ 100 kHz) > 2 mA <sub>p-p</sub> (voor AC mA) > 0.2 A <sub>p-p</sub> (voor ACA)

## (10) Temperatuur (alleen NI 99III)

Bereik	Resolutie	Nauwkeurigheid*
-40 °C...+400 °C	0.1 °C	$\pm (1.0 \% + 10 \text{ d})$
-40 °F...+752 °F	0.1 °F	$\pm (1.0 \% + 18 \text{ d})$

Bescherming tegen overbelasting	1000 VAC/DC RMS
---------------------------------	-----------------

\* Exclusief nauwkeurigheid van de gebruikte thermokoppel

\* Nauwkeurigheid specificatie is gebaseerd op een niet fluctuerende omgevingstemperatuur  $\pm 1^\circ\text{C}$ . Indien de omgevingstemperatuur  $\pm 5^\circ\text{C}$  veranderd is de aangegeven nauwkeurigheid geldt na 2 uur.

### (11) AC+DC spanning

Bereik	Resolutie	Nauwkeurigheid NI 98III	Nauwkeurigheid NI 99III
6.000 V	0.001 V		
60.00 V	0.01 V		
600.0 V	0.1 V	$\pm (2.5 \% + 5 \text{ d})$	$\pm (2.0 \% + 5 \text{ d})$
1000 V	1 V		

Aanvullende specificaties zijn identiek aan de spanningfunctie

### (12) AC+DC mV

Bereik	Resolutie	Nauwkeurigheid NI 98III	Nauwkeurigheid NI 99III
60.00 mV	0.01 mV	-	
600.0 mV	0.1 mV	$\pm (2.5 \% + 5 \text{ d})$	$\pm (2.0 \% + 10 \text{ d})$

Aanvullende specificaties zijn identiek aan de spanningfunctie

### (13) AC+DC mA

Bereik	Resolutie	Nauwkeurigheid NI 98III	Nauwkeurigheid NI 99III
60.00 mA	0.01 mA		
600.0 mA	0.1 mA	$\pm (2.5 \% + 5 \text{ d})$	$\pm (2.0 \% + 5 \text{ d})$

Aanvullende specificaties zijn identiek aan de stroomfunctie

### (14) AC+DC A

Bereik	Resolutie	Nauwkeurigheid NI 98III	Nauwkeurigheid NI 99III
6.000 A	0.0001 A		
10.00 A	0.01 A	$\pm (2.5 \% + 5 \text{ d})$	$\pm (2.0 \% + 5 \text{ d})$

Aanvullende specificaties zijn identiek aan de stroomfunctie



## 7 Onderhoud

Bescherm de meter tegen slechte weersomstandigheden. De meter is niet waterdicht. Stel het LCD-scherf niet gedurende lange perioden bloot aan direct zonlicht.



Let op: Om schade aan de meter te voorkomen, dient u de meter niet bloot te stellen aan sprays, vloeistoffen, of oplosmiddelen.



Reinig de buitenkant van de meter met een pluisvrije doek. Voorkom dat u krassen maakt op het LCD-scherf.



Gebruik eventueel een vochtige zachte doek of keukenpapier. U kunt een oplossing van 75% isopropylalcohol gebruiken om de meter nog beter schoon te maken.



Om schade aan het oppervlak van de meter te voorkomen, dient u geen schuurmiddelen of chemische schoonmaakmiddelen te gebruiken.

### Batterij vervangen

Als het batterij symbool knipperend verschijnt, moet de batterij vervangen te worden.

1. Haal de meetsnoeren los van de stroomkring die gemeten wordt en schakel de meter uit
2. Verwijder de meetsnoeren uit de meter
3. Draai de schroef van de batterijdekplaat aan de onderkant van de kast los
4. Verwijder de batterijdeksel
5. Plaats de nieuwe batterij aan nadat u de oude hebt verwijderd
6. Breng de batterijdekplaat weer op de onderkant van de behuizing aan met de schroef die beschreven is in stap 3

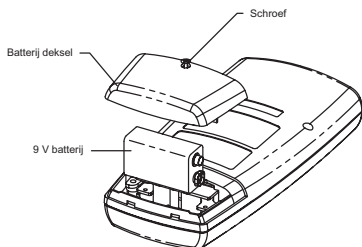

## Zekering vervangen

1. Volg stap 1 tot en met 4 van 'Batterij vervangen'
2. Verwijder de batterij uit de multimeter
3. Verwijder de 4 schroeven uit de onderkant van de multimeter
4. Haal de onderkant van de kast van de behuizing
5. Vervang de zekering door een nieuwe (zekering 1 of zekering 2)
6. Monteer de onderkant van de behuizing
7. Plaats de batterij die u eerder hebt verwijderd en sluit de batterijdeksel

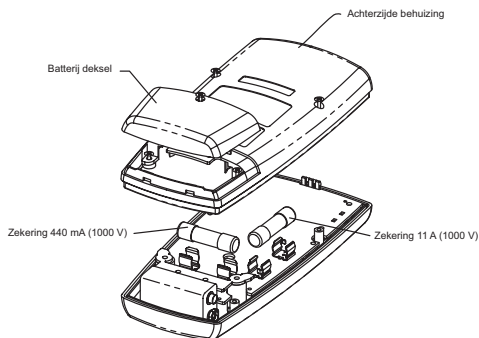

Zekering 440 mA 1000 V  
Zekering 11 A 1000 V

626006040  
626006041



Waarschuwing: het aanbrengen van onjuiste zekeringen kan tot ongevallen en schade aan het instrument leiden.

## 8 Accessoires

De volgende accessoires worden standaard meegeleverd:

- Holster incl. steun
- Batterij (9 V, reeds geplaatst)
- Handleiding
- Meetsnoeren
- Temperatuur meetsensor (alleen NI 99III)
- Ophangmagneet

## Contents

1	Safety	29
2	Description	31
3	Front panel	32
4	Function buttons	
	Yellow button	33
	Range button	33
	Min-max button	34
	Peak hold button (NI 99III only)	35
	Smart hold button	35
	VoltSense	36
	Illumination	36
	Auto power off	37
	Disable auto power off	37
5	Operation	
	Voltage measurement	38
	Current measurement	39
	Frequency	40
	Resistance / capacitance	41
	Continuity / diode	42
	Temperature (NI 99III only)	43
6	Specifications	
	General specifications	44
	Environmental specifications	44
	Electrical specifications	
	- (1) Voltage	45
	- (2) Auto-V / LOZ	46
	- (3) Current	46
	- (4) Peak hold	47
	- (5) Resistance	47
	- (6) Continuity check	47
	- (7) Diode test	47
	- (8) Capacitance	48
	- (9) Frequency	48
	- (10) Temperature (NI 99III only)	48
	- (11) AC+DC voltage	49
	- (12) AC+DC mV	49
	- (13) AC+DC mA	49
	- (14) AC+DC A	49
7	Maintenance	50
	Battery replacement	50
	Fuse replacement	51
8	Accessories	52

# 1 Safety

Take the following precautions to avoid prevent injury or damage to this instrument or products that are connected. To avoid potential hazards, the instrument may only be used in the specified manner.



Note: Identifies conditions and actions that could lead to damage to the instrument or other matter.



Warning: These statements identify conditions or actions that could lead to accidents.

Symbols on the product:



See instruction manual



Equipment protected by double or reinforced insulation



DC measurement



AC measurement



Battery indicator



Fuse



Risk of electric shock



Conforms to EU directives



Do not discard this product or throw away













## Specific precautions

### Do not use with open housing.

To prevent injury, never use the instrument to measure voltage or current when the cabinet is not properly fastened.

### Prevent electrical hazard.

To avoid accidents, do not connect or disconnecting the test leads while they are connected to a voltage source.

-  When using test leads or probes, keep your fingers behind the finger guards
-  Remove test lead from meter before opening the battery door or meter case
-  Use the meter only as specified in this manual or the protection by the meter might be impaired
-  Always use proper terminals, switch position and range for measurements
-  Verify the meter's operation by measuring a known voltage, if in doubt, have the meter serviced
-  Do not apply more than the rated voltage, as marked on the meter, between terminals or between any terminal and earth ground
-  Only replace the blown fuse with the proper rating as specified in this manual
-  Use caution with voltages above 30 VAC RMS, 42 VAC peak, or 60 VDC. These voltages pose a shock hazard
-  To avoid false readings that can lead to electric shock and injury, replace battery as soon as low battery indicator
-  Disconnect circuit power and discharge all highvoltage capacitors before testing resistance, continuity, diodes, or capacitance
-  Do not use meter around explosive gas or vapor
-  To reduce the risk of fire or electric shock do not expose this product to rain or moisture

## 2 Description

The multimeter has multiple functions and options. These possibilities are described in this manual.

### Functions

- Voltage AC/DC
- Current AC/DC
- Frequency
- Resistance
- Capacity
- Continuity
- Diode
- Temperature °C/°F (NI 99III only)

### Features

- Display with analog bar graph, consisting of 62 segments
- Extra large display with on/off switchable bright lighting
- True RMS
- 0.08% basic VDC accuracy
- Automatic AC/DC voltage detection with low impedance (Auto-V LoZ)
- VolteSense (non-contact voltage detection)
- Smart data hold
- Peak hold (1 ms) (NI 99III only)
- Min - max function
- AC + DC function
- Frequency counter in AC mode
- Capacity measurement
- Temperature (NI 99III only)
- Circuit breaker control
- Battery indicator
- Auto off (20 minutes)
- CAT IV 600 V / CAT III 1000 V
- CE marking

### 3 Front panel

Examine the following numbered steps to familiarize yourself with the controls and the connectors on the front panel of the multimeter.

1. Display
2. Push-buttons
3. Rotary switch
4. Input terminal for A
5. Input terminal for V,  $\Omega$ ,  $^{\circ}\text{C}^*$  functions
6. Common (ground reference) input terminal
7. Input terminal for mA

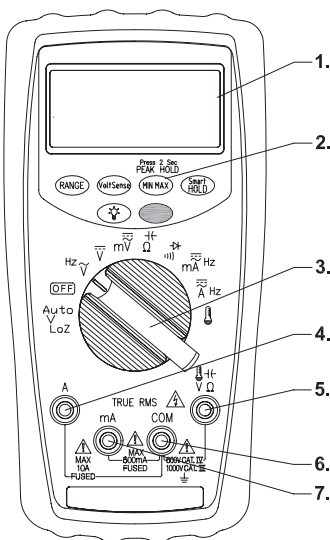

#### Inspection

Once your new digital multimeter has been unpacked from the original packaging, you should have the following items:

1. Digital multimeter
2. Set of test leads (one black, one red)
3. Operation manual
4. Protective holster
5. Hanging kit
6. K-type temperature sensor (NI 99III only)



## 4 Function buttons

### Yellow button

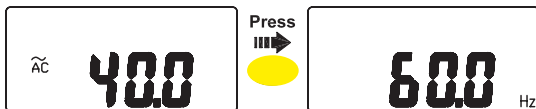

Switch Position	Function
Hz $\tilde{V}$	$\tilde{V} \Rightarrow$ Hz
m $\tilde{V}$	m $\tilde{V} \Rightarrow$ m $\tilde{V}$
$\Omega$	$\Omega \Rightarrow$ $\Omega$
$\text{    }$	$\text{    } \Rightarrow$ $\text{    }$
m $\tilde{A}$ Hz	m $\tilde{A} \Rightarrow$ Hz $\Rightarrow$ m $\tilde{A}$
$\tilde{A}$ Hz	$\tilde{A} \Rightarrow$ Hz $\Rightarrow$ $\tilde{A}$
	$^{\circ}\text{C} \Rightarrow$ $^{\circ}\text{F}$

Press the yellow function key to toggle between the various available measurement functions.

### Range button

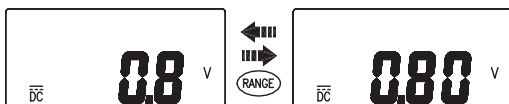

Press  button  
to select the display range.

## Min-max button

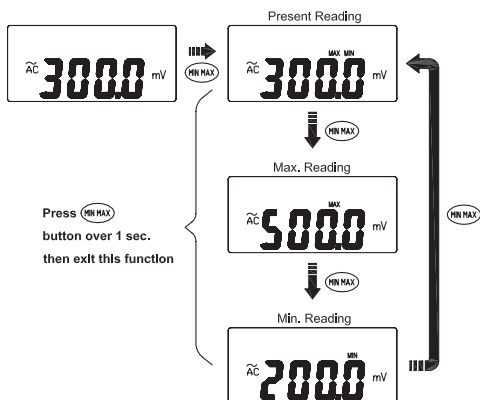

The Min-max mode records the min. and max. input values. When the input goes below the recorded min. value or above the recorded max. value, the meter records the new value. Press the hold button to pause the recording.

By holding the "Min-max" button for 1 sec this function will be ended.

## Peak hold (NI 99III only)

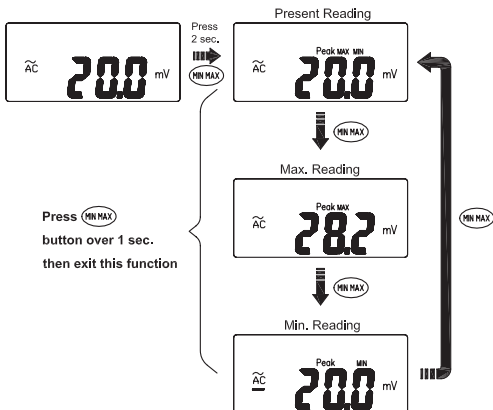

In the Peak hold function, the meter records the peak minimum value and the peak maximum value when the inputs goes below the recorded peak minimum value or above the recorded peak maximum value, the meter records the new value. Press Hold button to pause the recording.

## Smart hold

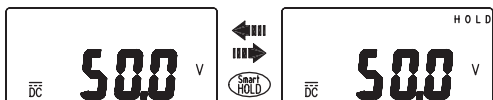

The meter will beep continuously and the display will flash if the measured signal is larger than the display reading by 50 counts. (However, it cannot detect across the AC and DC Voltage / Current).

## VoltSense (Non-contact voltage detection)

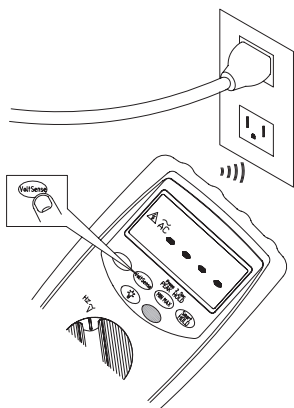

Hold the VoltSense button to use this function. The number of dashes on the display indicated the strength of the electric field that is detected.



Warning: If there is no indication, voltage could still be present.

## Illumination

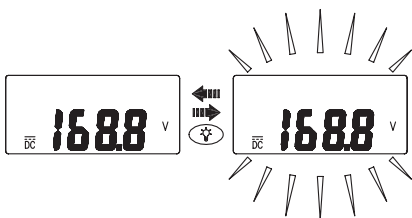

Through the red light button, the backlight can be switched on or off.

## Auto power off

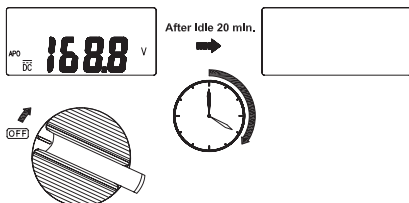

After 20 minutes of idle the multimeter will go into sleep mode. Wake-up the meter by dialing the switch or pressing any button.

## Disable auto power off

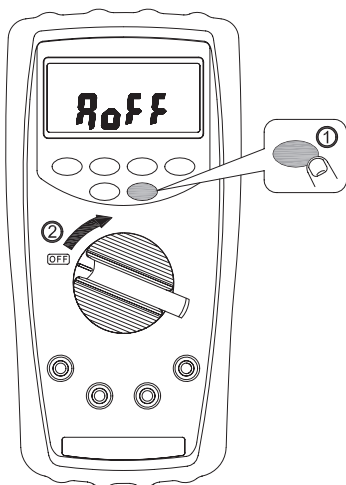

The auto power off function can be disabled by holding the yellow button and turning the multimeter on. On the display Roff will be mentioned.

## 5 Operation

### Voltage measurement

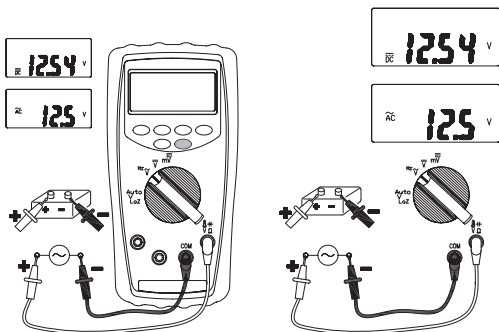

1. Connect the red test lead to the "V  $\Omega$ "- connection and the black test lead to the "COM" terminal
2. Turn the rotation switch on "V~", "V  $\overline{\text{---}}$ " or "mV"
3. By pressing the yellow button it is possible to change the function that is indicated in yellow above the selected function
4. Connect the test lead to the to measure object

## Current measurement

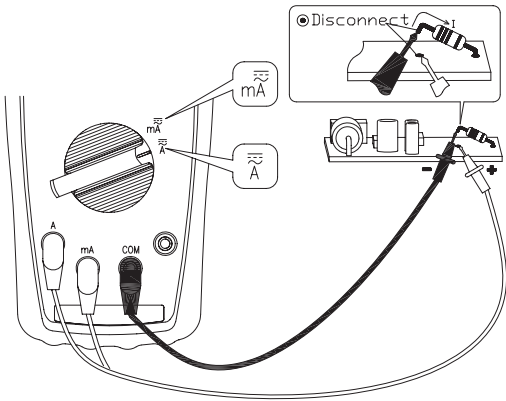

1. Connect the red test lead to the "mA" or "A" terminal, depending of the requested measuring that you want to make. Connect the black test lead to the "COM" terminal
2. Turn the rotation switch on "mA" or "A"
3. The meter is standard in AC mode, by pressing the yellow button it is possible to change the mode to DC or AC+DC mode. The display indicates what kind of mode is selected
4. Connect the test lead to the to measure object

## Frequency



Press the function button to select the measuring function.

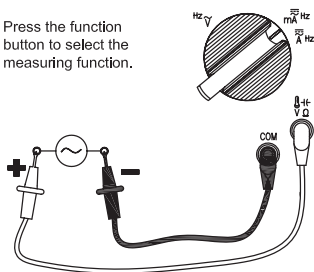

1. Connect the red test lead to the "V Ω" terminal and the black test lead to the "COM" terminal
2. Set the rotary switch to the "~ V / Hz" position
3. Press the yellow button to turn the meter in Hz mode
4. Connect the test lead to the to measure object



## Resistance / capacitance measurement

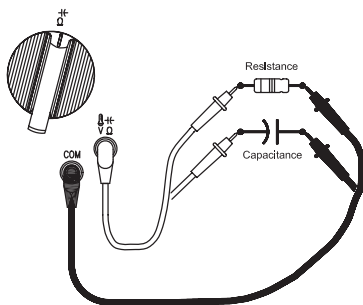

1. Connect the red test lead to the "Ω V Ω" terminal and the black test lead to the "COM"
2. Set the rotary switch to the "Ω V Ω" position
3. By pressing the yellow button the measuring function can be changed from Ω to μF mode
4. Connect the test lead to the to measure object

## Continuity / diode measurement

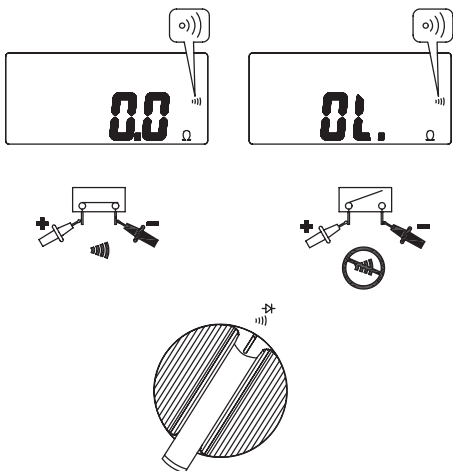

1. Connect the red test lead to the "V  $\Omega$ " terminal and the black test lead to the "COM"- terminal
2. Set the rotary switch to the " " position
3. By pressing the yellow button the measuring function can be changed from a Continuity measuring " " to a diode measuring " "
4. Connect the test lead to the to measure object

## Temperature °C/°F (NI 99III only)

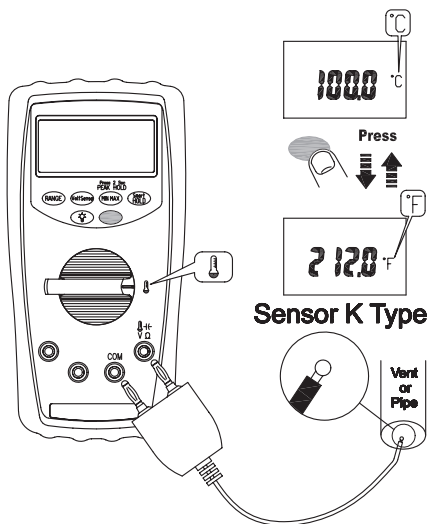

1. Connect the + of the sensor to the "V  $\Omega$ " terminal and the other to the "COM"- terminal
2. Turn the switch on the temperature measuring mode "
3. By pressing the yellow button the measuring value can be changed from Celsius "°C" to Fahrenheit "°F"

## 6 Specifications

### General specifications

Display	LCD, 6000 digit
Polarity Indication	Automatic, positive implied, negative indicated
Out of range indication	OL
Power requirement	9V battery
Batterij indication	Flashes when voltage drops below operating voltage
Battery life	150 hours Alkaline battery (when using no backlight)
Auto Power Off	20 minutes
Operating temperature	-10 °C...10 °C 10 °C...30 °C, ( $\leq$ 80% RH) 30 °C...40 °C, ( $\leq$ 75% RH) 40 °C...50 °C, ( $\leq$ 45% RH)
Storage temperature	-20 °C...60 °C, 0 to 80% RH (batteries not fitted)
Temperature coefficient	0.15 x (spec. accy) / °C, $<$ 18°C or $>$ 28 °C
Dimensions	460 g (incl. batteries)
Dimensions (lxhxd)	94 x 190 x 48 mm, incl. holster
Accessories	Holster, battery (installed), test leads, hanging kit, temperature sensor (NI 99III only) and manual.

### Environmental conditions

Maximum height	2000 meter
Installation category	Complies with EN 61010-1, UL 61010-1, IEC 1010-1, CAT IV 600 V, CAT III 1000 V
EMC	EN 61326-1
Pollution degree	2

## Electrical specifications

Accuracy is  $\pm$  (% reading + number of digits) at 23 °C,  $\pm$  5 °C at a humidity of less than 80%

### (1) Voltage

Range	Resolution	Accuracy NI 98III	Accuracy NI 99III
60.00 m VDC	0.01 mV	-	$\pm$ (0.08 % + 10 d)
600.0 m VDC	0.1 mV	$\pm$ (0.1 % + 2 d)	$\pm$ (0.08 % + 2 d)
6.000 VDC	0.001 V	$\pm$ (0.09 % + 2 d)	$\pm$ (0.08 % + 2 d)
60.00 VDC	0.01 V	$\pm$ (0.09 % + 2 d)	$\pm$ (0.08 % + 2 d)
600.0 VDC	0.1 V	$\pm$ (0.09 % + 2 d)	$\pm$ (0.08 % + 2 d)
1000 VDC	1 V	$\pm$ (0.09 % + 2 d)	$\pm$ (0.08 % + 2 d)
60.0 m VAC	0.1 mV	-	$\pm$ (1.20 % + 5 d)
600.0 m VAC	0.1 mV	$\pm$ (1.5 % + 5 d)	$\pm$ (1.20 % + 5 d)
6.000 VAC	0.001 V	$\pm$ (1.0 % + 3 d)	$\pm$ (0.80 % + 5 d)
60.00 VAC	0.01 V	$\pm$ (1.0 % + 3 d)	$\pm$ (0.80 % + 5 d)
600.0 VAC	0.1 V	$\pm$ (1.0 % + 3 d)	$\pm$ (0.80 % + 5 d)
1000 VAC	1 V	$\pm$ (1.0 % + 3 d)	$\pm$ (0.80 % + 5 d)

Overload protection	1000 VAC/DC RMS
AC frequency	50 Hz ~ 1 KHz
Input impedance	10 M $\Omega$ , < 100 pF
AC conversion type	AC conversions are ac-coupled, true RMS responding, calibrated to the sine wave input
Crest factor	1.4 to 2.0, add 1.0% to accuracy 2.0 to 2.5, then add 2.5% to accuracy 2.5 to 3.0, add 4.0% to accuracy

## (2) Auto-V (automatic voltage selection)

Range	Resolution	Accuracy NI 98III	Accuracy NI 99III
600.0 VDC	0.1 V	± (1.0 % + 3 d)	± (0.80 % + 3 d)
1000 VDC	1 V		
600.0 VAC	0.1 V		
1000 VAC	1 V		

Overload protection	1000 VAC/DC RMS
AC frequency	50 Hz ~ 1 KHz
Input impedance	± 3 kΩ
AC conversion type	AC conversions are ac-coupled, true RMS responding, calibrated to the sine wave input

## (3) Current

Range	Resolution	Accuracy NI 98III	Accuracy NI 99III
60.00 m ADC	0.01 mA	± (0.1 % + 3 d)	± (0.8 % + 3 d)
600.0 m ADC	0.1 mA	± (0.1 % + 3 d)	± (0.8 % + 3 d)
6.000 ADC	0.001 A	± (0.1 % + 3 d)	± (0.8 % + 3 d)
10.00 VDC	0.01 A	± (0.1 % + 3 d)	± (0.8 % + 3 d)
60.00 m AAC	0.01 mA	± (1.5 % + 3 d)	± (1.2 % + 3 d)
600.0 mAAC	0.1 mA	± (1.5 % + 3 d)	± (1.2 % + 3 d)
6.000 AAC	0.001 A	± (1.5 % + 3 d)	± (1.2 % + 3 d)
10.00 AAC	0.01 A	± (1.5 % + 3 d)	± (1.2 % + 3 d)

Input protection	Equipped with high energy fuse; 440 mA, 1000 VAC/DC 10 KA fuse for mA input, 11 A, 1000 VAC/DC 20 KA Fuse for A input
Max. measuring time	3 minutes for A input, 10 minutes for mA input Rest time 20 minutes
AC frequency	50 Hz ~ 1 KHz
AC conversion type	AC conversions are ac-coupled, true RMS responding, calibrated to the sine wave input

#### (4) Peak hold (NI 99III only)

Accuracy approx. 150 d

#### (5) Resistance

Range	Resolution	Accuracy
600.0 $\Omega$	0.1 $\Omega$	$\pm (0.8 \% + 5 \text{ d})$
6000.0 K $\Omega$	0.001 K $\Omega$	
60.00 K $\Omega$	0.01 K $\Omega$	$\pm (0.8 \% + 5 \text{ d})$
600.0 K $\Omega$	0.1 K $\Omega$	
6.000 M $\Omega$	0.001 M $\Omega$	
40.00 M $\Omega$	0.01 M $\Omega$	$\pm (1.0 \% + 5 \text{ d}) < 10 \text{ M}\Omega$ $\pm (1.0 \% + 5 \text{ d}) > 10 \text{ M}\Omega$

Input protection	1000 VAC/DC RMS
Max. open circuit voltage	Approx. 2.5 V for 600 $\Omega$ & 6 k $\Omega$ range Approx. 0.6 V for others
Max. test current	Ca. 0.1 mA

#### (6) Continuity check

Range	Resolution	Accuracy
600.0 $\Omega$	0.1 $\Omega$	$\pm (0.8 \% + 5 \text{ d})$

Input protection	1000 VAC/DC RMS
Max. open circuit voltage	Ca. 2.5 V
Max. test current	Ca. 0.1 mA
Continuity threshold	< 30 $\Omega$ beep on < 100 $\Omega$ beep off
Continuity indicator	2.7 KHz tone buzzer

#### (7) Diode test

Range	Resolution	Accuracy
2.000 V	1 mA	$\pm (1.5 \% + 2 \text{ d})$

Input protection	1000 VAC/DC RMS
Max. open circuit voltage	Ca. 2.5 V
Max. test current	Ca. 0.4 mA

## (8) Capacitance

Range	Resolution	Accuracy
1.000 $\mu$ F	0.001 $\mu$ F	$\pm (1.2 \% + 2 \text{ d})$
10.00 $\mu$ F	0.01 $\mu$ F	
100.0 $\mu$ F	0.1 $\mu$ F	
1.000 mF	0.001 mF	
10.00 mF	0.01 mF	

Input protection	1000 VAC/DC RMS
Max. measuring time	0.7 sec for 1 nF ~ 1 mF 3 sec for 1 mF ~ 10 mF

## (9) Frequency

Range	Resolution	Accuracy
100.00 Hz	0.01 Hz	$\pm (0.1 \% + 2 \text{ d})$
1000.0 Hz	0.1 Hz	
10.000 KHz	0.001 KHz	
100.00 KHz	0.01 KHz	

Input protection	1000 VAC/DC RMS
Min. frequency	1 Hz
Sensitivity	> 5.0 VDC (for ACV 1 Hz ~ 10 kHz) > 10 V <sub>p-p</sub> (for ACV 10 kHz ~ 100 kHz) > 2 mA <sub>p-p</sub> (for AC mA) > 0.2 A <sub>p-p</sub> (for ACA)

## (10) Temperature (NI 99III only)

Range	Resolution	Accuracy*
-40 °C...+400 °C	0.1 °C	$\pm (1.0 \% + 10 \text{ d})$
-40 °F...+752 °F	0.1 °F	$\pm (1.0 \% + 18 \text{ d})$

Input protection	1000 VAC/DC RMS
------------------	-----------------

\* Does not include accuracy of the thermocouple probe

\* Accuracy specification assumes surrounding temperature stable to  $\pm 1$  °C for surrounding temperature changes of  $\pm 5$  °C, rated accuracy applies after 2 hours



## (11) AC+DC voltage

Note: The AC+DC True RMS vale might be over selected range since the AC single on DC level.

Range	Resolution	Accuracy NI 98III	Accuracy NI 99III
6.000 V	0.001 V		
60.00 V	0.01 V		
600.0 V	0.1 V	$\pm (2.5 \% + 5 \text{ d})$	$\pm (2.0 \% + 5 \text{ d})$
1000 V	1 V		

Additional specification are same as voltage function.

## (12) AC+DC mV

Range	Resolution	Accuracy NI 98III	Accuracy NI 99III
60.00 mV	0.01 mV	-	
600.0 mV	0.1 mV	$\pm (2.5 \% + 5 \text{ d})$	$\pm (2.0 \% + 10 \text{ d})$

Additional specification are same as voltage function.

## (13) AC+DC mA

Range	Resolution	Accuracy NI 98III	Accuracy NI 99III
60.00 mA	0.01 mA		
600.0 mA	0.1 mA	$\pm (2.5 \% + 5 \text{ d})$	$\pm (2.0 \% + 5 \text{ d})$

Additional specification are same as current function

## (14) AC+DC A

Range	Resolution	Accuracy NI 98III	Accuracy NI 99III
6.000 A	0.0001 A		
10.00 A	0.01 A	$\pm (2.5 \% + 5 \text{ d})$	$\pm (2.0 \% + 5 \text{ d})$

Additional specification are same as current function

## 7 Maintenance

Protect the meter from adverse weather. The meter is not waterproof. Do not adjust the LCD screen for prolonged periods in direct sunlight.



Note: To prevent damage to the meter, the meter should not be exposed to sprays, liquids, or solvents.



Clean the exterior of the meter with a lintfree cloth. To prevent the plastic LCD screen from scratching use a soft damp cloth or paper towel. A 75% isopropyl alcohol may be used in order to clean the meter properly.



To prevent damage to the surface of the meter, do not use abrasives or chemical cleaners to clean the surface.

### Battery replacement

When the battery symbol starts flashing, the battery should be replaced.

1. Remove the test leads from the circuit being measured and turn off the meter
2. Remove test leads from the meter
3. Loosen the screw of the battery cover on the bottom of the housing
4. Remove battery cover
5. Insert a new battery after you have removed the old one
6. Place the battery cover back on the bottom of the housing with the screw, which has been described in step 3

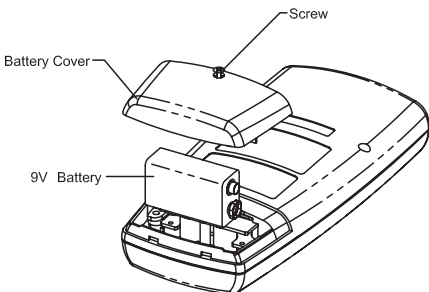

## Fuse replacement

1. Follow steps 1 through 4 of the above paragraph battery replacement
2. Remove the battery from the meter
3. Remove the 4 screws from the bottom of the meter
4. Separate the battery terminal and the bottom housing of the meter from each other.
5. Remove the 4 screws from the PCB and the top of the housing
6. Replace the fuse with a new (fuse 1 or fuse 2)
7. Replace the bottom of the housing
8. Insert the battery that you previously removed and replace the battery cover and tighten the screw

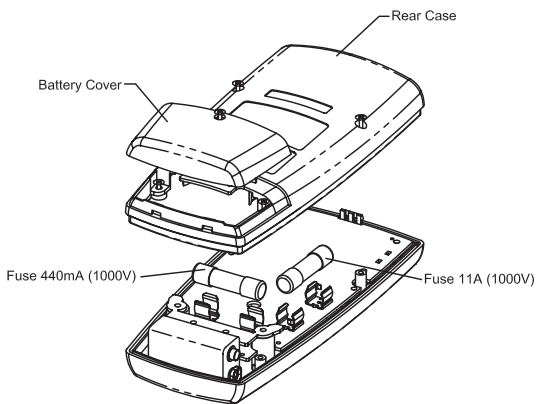

Fuse 440 mA 1000 V 626006040  
Fuse 11 A 1000 V 626006041



Warning: the application of incorrect fuse can cause accidents and damage to the instrument

## 8 Accessories

The following accessories are included:

- Holster including support
- Battery (9 V, already installed)
- Manual
- Test leads
- Temperature measurement sensor (NI 99III only)
- Hanging kit



## Mors Smitt B.V.

Vrieslantlaan 6  
3526 AA Utrecht

Postbus 7023  
3502 KA Utrecht  
The Netherlands

T +31 (0)30 288 13 11  
F +31 (0)30 289 88 16  
E [sales@nieaf-smitt.nl](mailto:sales@nieaf-smitt.nl)  
I [www.nieaf-smitt.nl](http://www.nieaf-smitt.nl)

## Helpdesk:

E [helpdesk@nieaf-smitt.nl](mailto:helpdesk@nieaf-smitt.nl)

I [www.nieaf-smitt.nl/support](http://www.nieaf-smitt.nl/support)

Versie V004

Art.no. 561144195

MAN-NI98III&NI99III V4.1

Date 01-03-2013

