

/// Socket, spring clamp terminal, wall / rail mount, 8 pole

Sockets for extreme reliability, within long endurance applications and harsh environments

V99 Socket

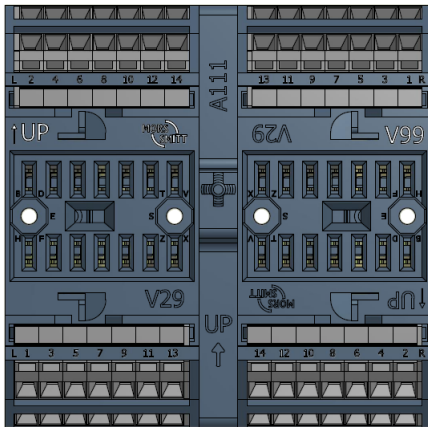

Features

- Surface / wall and 35 mm rail mount
- Sturdy spring clamp terminals
- No internal solderings / connections
- Suitable for all railway and industry D8- and KDN-relay series
- Touch proof IP20
- Height saving 35 mm rail mounting
- Up to two wires of 2.5 mm² per relay contact
- Easy & quick installation (up to 75% reduction of wiring time)
- Positive mechanical keying
- Trifurcated female receiver for tight grip relay pin
- Clear terminal ID

Description

The V99 is a surface / wall and 35 mm rail mount relay socket. The V99 socket has two spring terminals per relay contact, so looping/daisy chaining can be done on the socket and no external connector or terminal is needed.

The spring terminal makes quick connection possible by pressing the spring with a flat-bladed screwdriver and inserting the stripped wire. Solid and (fine) stranded wire up to 2.5 mm² can be inserted. This quick & easy wiring method saves up to 75% wiring time compared with classic technology, like screw terminals.

To prevent fault relay placement the socket can be equipped with mechanical keying to accept only designated identical keyed relays.

Clear UP arrow for correct 35 mm rail mounting.

Application

The V99 relay socket is suitable for general railway and industry applications with a space saving design. Installation and replacement of relays is made easy and cost saving. No maintenance is required for the user.

Suitable for all railway and industry D8- and KDN-relay series.

Connection diagram

Top view

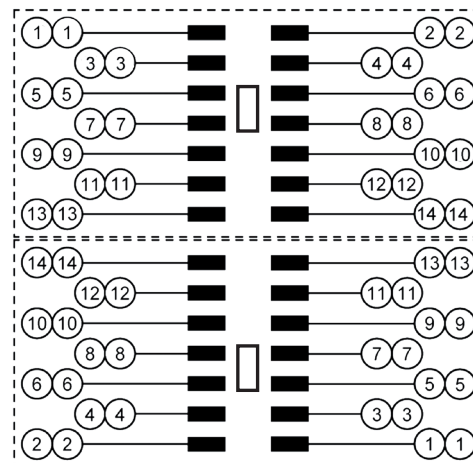

Railway compliancy

EN 50155
IEC 60571
EN 45545-2
NF F16-101/102
NF F 62-002

Industry compliancy

EN 60947-5-1
IEC 61810

Technical specifications

Technical characteristics

Contact rating		10 A
Dielectric strength	IEC 60255, IEC 60571	3500 V, 50 Hz, 1 min
Protecting category	IEC 60529	IP20
Mounting		Surface / wall and 35 mm rail
Max. ambient temperature		80 °C
Weight		186 g
Dimensions		87 x 88 x 34.1 mm
Wire size		0.08 - 2.5 mm ² maximum
Wire stripping length		6 mm
Material		Polyamide 66, 30% glass
Socket contacts		Spring clamp terminal
Max. torque value mounting screws		1 Nm
Accessories		A104 Key receptable

For more detailed technical specifications, drawings and ordering information, go to the product page on www.morssmitt.com

 **Over 10 million Mors Smitt relays in use in applications worldwide!**

Mors Smitt Asia Ltd.
 Unit B & C, 25/F., Casey Aberdeen House
 38 Heung Yip Road, Wong Chuk Hang
 Hong Kong
 Tel: +852 2343 555
sales.msa@wabtec.com

Mors Smitt France SAS
 2 Rue de la Mandinière
 72300 Sablé-sur-Sarthe, France
 Tel: +33 (0) 243 92 82 00
sales.msf@wabtec.com

Mors Smitt UK Ltd.
 Graycar Business Park,
 Burton on Trent, DE13 8EN, UK
 Tel: +44 (0)1283 357 263
sales.msuk@wabtec.com

Wabtec Netherlands B.V.
 Darwinstraat 10,
 6718 XR Ede, Netherlands
 Tel: +31 (0)88 600 4555
sales.msbv@wabtec.com

Mors Smitt Technologies Ltd.
 1010 Johnson Drive,
 Buffalo Grove, IL 60089-6918, USA
 Tel: +1 847 777 6497
salesmst@wabtec.com

RMS Mors Smitt
 6 Anzed Court,
 Mulgrave, VIC 3170, Australia
 Tel: +61 (0)3 8544 1200
sales.rms@wabtec.com

(c) Copyright 2020

All rights reserved. Nothing from this edition may be multiplied, or made public in any form or manner, either electronically, mechanically, by photocopying, recording, or in any manner, without prior written consent from Mors Smitt. This also applies to accompanying drawings and diagrams. Due to a policy of continuous development Mors Smitt reserves the right to alter the equipment specification and description outlined in this datasheet without prior notice and no part of this publication shall be deemed to be part of any contract for the equipment unless specifically referred to as an inclusion within such contract. Mors Smitt does not warrant that any of the information contained herein is complete, accurate, free from potential errors, or fit for any particular purpose. Mors Smitt does not accept any responsibility arising from any party's use of the information in this document.

Socket V99

Dimensions

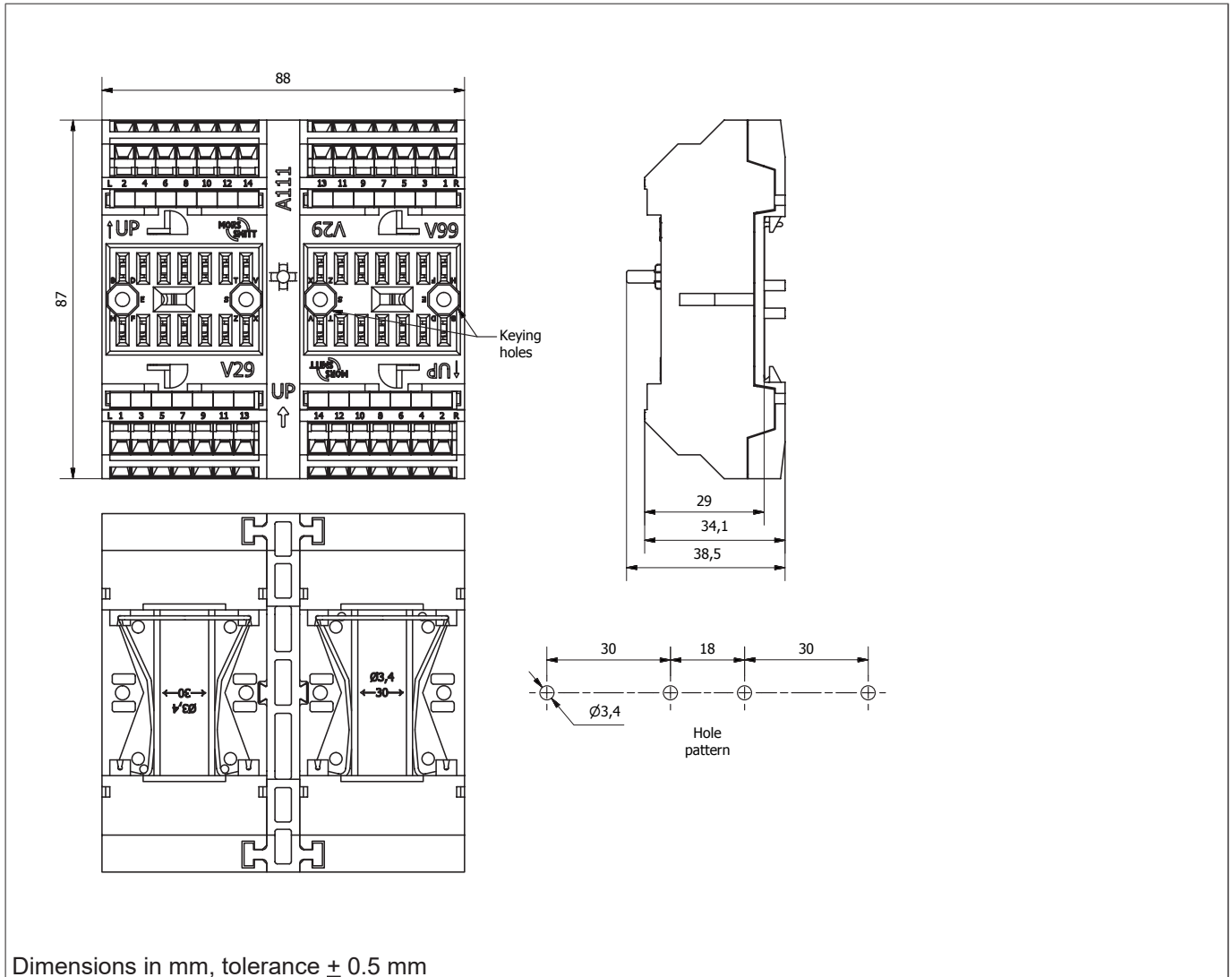

Railway compliancy

EN 50155	Railway applications - Rolling stock - Electronic equipment
IEC 60571	Railway applications - Electronic equipment used on rolling stock
NF F16-101/102	Railway rolling stock - Fire behavior
EN 45545-2	Railway applications - Fire protection on railway vehicles Part 2: Requirements for fire behavior of materials and components
NF F 62-002	Railway rolling stock - On-off contact relays and fixed connections

Industry compliancy

EN 60947-5-1	Electromechanical control circuit devices and switching elements
IEC 61810	Electromechanical elementary relays

V29

V29 Spring terminal relay socket for 4 contact relays (all D & D-U relays).



For detail see DS-V29 socket

Tri-furcated female receiver for tight grip relay pin

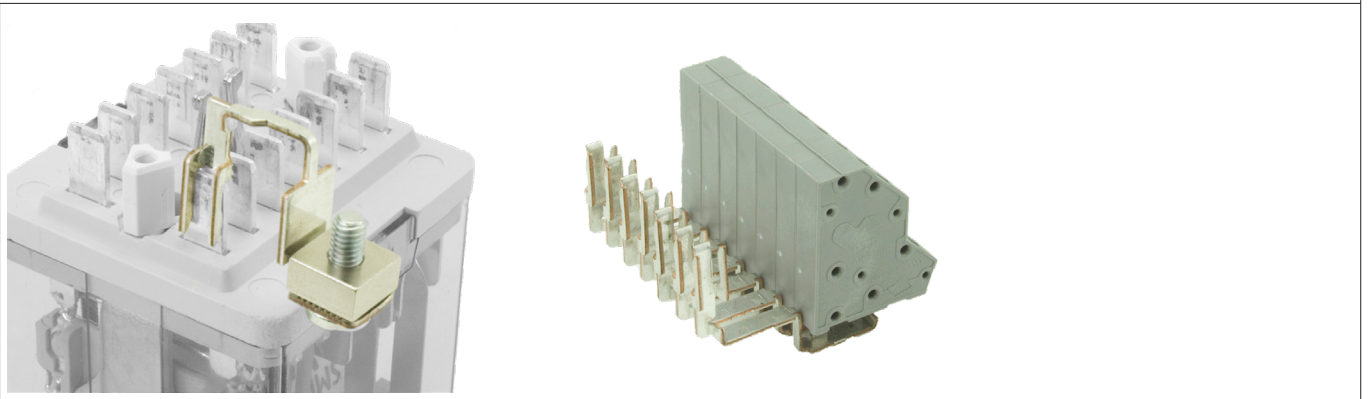

Mechanical keying relay and socket (optional)

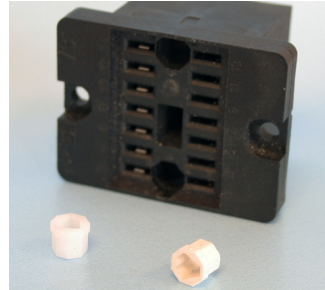
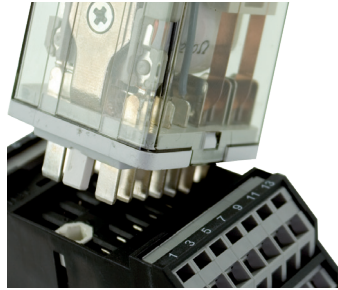

Function:

- To prevent wrong installation
- To prevent damage to equipment
- To prevent unsafe situations

Using keyed relays and sockets prevents a relay is inserted in a wrong socket. For example it prevents that a 24 VDC relay is put in a 110 VDC circuit. Positive discrimination is possible per different function, coil voltage, timing, monitoring, safety and non-safety.

The D-relay socket keying option gives $8 \times 8 = 64$ possibilities. Upon ordering the customer simply indicates the need for the optional keying. Mors Smitt will assign a code to the relay and fix the pins into the relay. The sockets are supplied with loose key receptacles. Inserting the keys into the socket is very simple and self explaining.

Remark: Sockets and relay shown are examples.

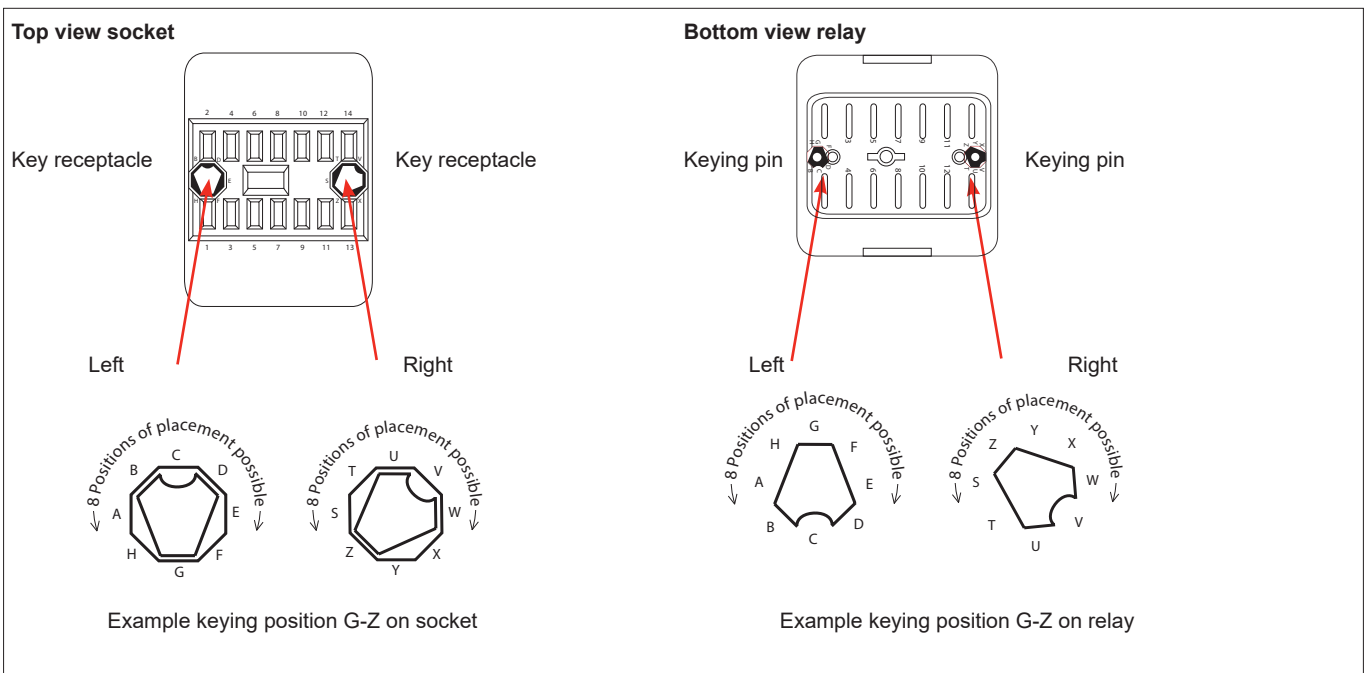

Installation and inspection

Installation

Before installation or working on the relay: disconnect the power supply first!

Install socket and connect wiring according to the terminal identification. Plug relay into the socket ensuring there is no gap between the bottom of relay and the socket. Reverse installation into the socket is not possible due to the mechanical blocking snap-lock feature.

No external retaining clip needed as the 'snap-lock' will hold the relay into the socket under all circumstances and mounting directions (according shock & vibration requirements IEC 61373, Category I, Class B, Body mounted). If regulations require an external retaining clip, this is available as well. For more information see the datasheet of the retaining clips.

When rail mounting is used, always mount the socket in the direction of the UP arrow.

The socket is designed to keep the relays in place on the rail, but not to avoid any sideways movement on the rail. Both the socket and the rail have dimensional tolerances, so depending on how these tolerances stack up, the socket can sometimes slide more or less. This can be prevented by commercially available end stops not manufactured by Mors Smitt. This prevents any sliding of the relay sockets or any other items installed along the rail.

Warning!

- To remove relays from the socket, employ up and down lever movements. Sideways movement may cause damage to the coil wires

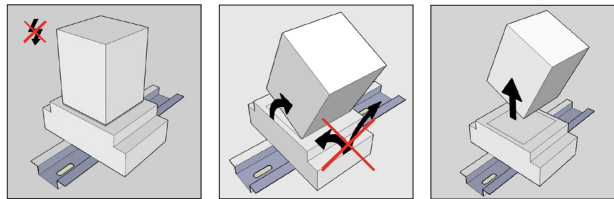

When plugging the relay into the socket, the female trifurcated receivers will automatically cut through the corrosion on the pins and guarantee a reliable connection.

Inspection

If the socket does not work after inspection of the correct wiring and relay connection, replace the unit with a similar model.

When returning products for investigation, please provide all information on the RMA form. Send defective products back to the manufacturer for repair or replacement. Normal wear and tear or external causes are excluded from warranty.

Socket V99

Ordering codes



Article no.	Code	Description
338000610	V29	Spring clamp terminal relay socket
338003950	V99	Spring clamp terminal relay socket for 8 contact relays
378690100	A104	Key receptacle

 **Over 10 million Mors Smitt relays in use in applications worldwide!**

Mors Smitt Asia Ltd.
 Unit B & C, 25/F., Casey Aberdeen House
 38 Heung Yip Road, Wong Chuk Hang
 Hong Kong
 Tel: +852 2343 555
sales.msa@wabtec.com

Mors Smitt France SAS
 2 Rue de la Mandinière
 72300 Sablé-sur-Sarthe, France
 Tel: +33 (0) 243 92 82 00
sales.msf@wabtec.com

Mors Smitt UK Ltd.
 Graycar Business Park,
 Burton on Trent, DE13 8EN, UK
 Tel: +44 (0)1283 357 263
sales.msuk@wabtec.com

Wabtec Netherlands B.V.
 Darwinstraat 10,
 6718 XE Ede, Netherlands
 Tel: +31 (0)88 600 4500
sales.msbv@wabtec.com

Mors Smitt Technologies Ltd.
 1010 Johnson Drive,
 Buffalo Grove, IL 60089-6918, USA
 Tel: +1 847 777 6497
salesmst@wabtec.com

RMS Mors Smitt
 6 Anzed Court,
 Mulgrave, VIC 3170, Australia
 Tel: +61 (0)3 8544 1200
sales.rms@wabtec.com

(c) Copyright 2020

All rights reserved. Nothing from this edition may be multiplied, or made public in any form or manner, either electronically, mechanically, by photocopying, recording, or in any manner, without prior written consent from Mors Smitt. This also applies to accompanying drawings and diagrams. Due to a policy of continuous development Mors Smitt reserves the right to alter the equipment specification and description outlined in this datasheet without prior notice and no part of this publication shall be deemed to be part of any contract for the equipment unless specifically referred to as an inclusion within such contract. Mors Smitt does not warrant that any of the information contained herein is complete, accurate, free from potential errors, or fit for any particular purpose. Mors Smitt does not accept any responsibility arising from any party's use of the information in this document.