

# V10 socket - Screw terminal, Datasheet wall / rail mount



## Description

The V10 is a surface / wall mount relay socket. Optional 35 mm rail mount with A109 rail clip. The V10 socket has one screw terminal per relay contact suitable for two wires up to 2.5 mm<sup>2</sup>, so looping/daisy chaining can be done on the socket and no external connector or terminal is needed.

To prevent fault relay placement the socket can be equipped with mechanical keying to accept only designated identical keyed relays.

## Application

The V10 relay socket is suitable for general industrial applications with a space saving design. Installation and replacement of relays is made easy and cost saving. No maintenance is required for the user.

Suitable for all CU-relay series.

### Features

- Surface / wall mount
- Optional 35 mm rail mount with A109 rail clip
- Sturdy screw terminals
- Space saving
- Suitable for all CU-relay series
- Up to two wires of 2.5 mm<sup>2</sup> per connection terminal
- Positive mechanical keying
- Bifurcated female receiver for tight grip relay pin
- Clear terminal ID

### Benefits

- Proven reliable
- Long term availability
- Easy to maintain
- Low life cycle cost
- No maintenance

### Industry compliancy

- EN 60947-5-1 - Electromechanical control circuit devices and switching elements
- IEC 61810 - Electromechanical elementary relays

# V10 socket

## Technical specifications

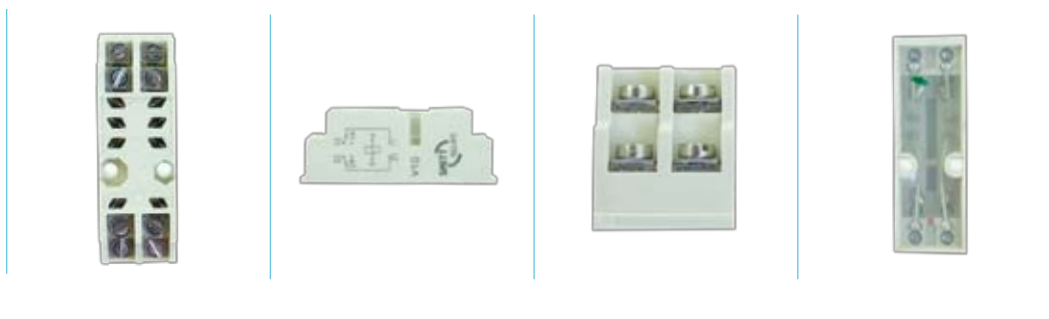

## Technical characteristics

Contact rating	8 A
Dielectric strength	IEC 60255 / IEC 60571, 2500 V, 50 Hz, 1 min 4 kV between terminals and mounting plate
Protecting category	IEC 60529, IP10
Mounting	Surface / wall mounting 35 mm rail mounting with A109 rail clip
Max. ambient temperature	80 °C
Weight	V10: 32 g A109: 5 g
Dimensions	65 x 20 x 23 mm
Wire size	2.5 mm <sup>2</sup> maximum
Material	Polyester
Socket contacts	Screws
Max. torque value mounting screws	1 Nm
Max. torque value terminal screws	1 Nm
Accessories	A104 Key receptacle A109 Rail clip A101 Retaining clip (low, locked in socket without relay) A110 Retaining clip (low, not locked in socket without relay) A020 Retaining clip (high)

## Dimensions

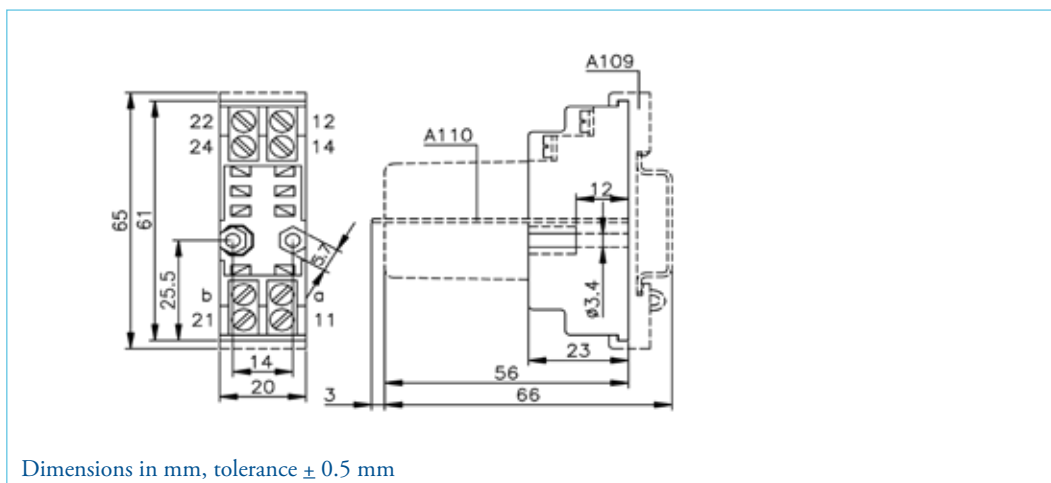

# V10 socket

## Technical specifications

### Mechanical keying relay and socket (optional)

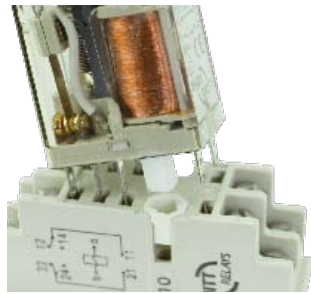

Function:

- To prevent wrong installation
- To prevent damage to equipment
- To prevent unsafe situations

Using keyed relays and sockets prevents a relay being inserted in a wrong socket. For example it prevents placing a 24 VDC relay in a 110 VDC circuit. Positive discrimination is possible per different function, coil voltage, timing, monitoring, safety and non-safety.

The C-relays socket keying option gives 8 possibilities. Upon ordering the customer simply indicates the need for the optional keying. Mors Smitt will assign a code to the relay and fix the pins into the relay. The sockets are supplied with loose key receptacles. Inserting the keys into the socket is very simple and self explaining.

Remark: sockets and relay shown are only examples.

#### Top view socket

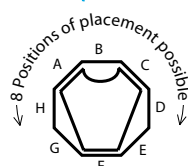
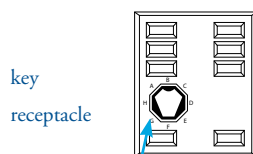

Example keying position B on socket

#### Bottom view relay

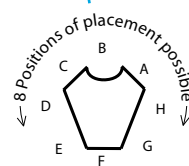
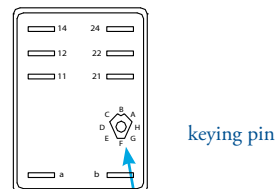

Example keying position B on relay



# V10 socket

## Technical specifications

### Installation & inspection

#### Installation

Before installation or working on the relay: disconnect the power supply first!

Install socket and connect wiring according to the terminal identification. Plug relay into the socket ensuring there is no gap between the bottom of relay and the socket. Reverse installation into the socket is not possible. Use a retaining clip to ensure good connection if necessary.

#### Warning!

- To remove relays from the socket, employ up and down lever movements. Sideway movement may cause damage to the coil wires.

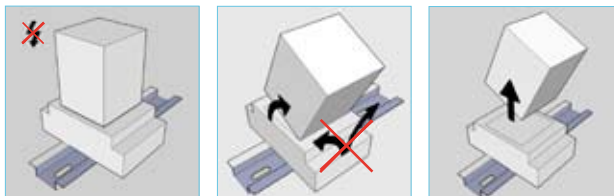

When plugging the relay into the socket, the female bifurcated receivers will automatically cut through the corrosion on the pins and guarantee a reliable connection.

#### Inspection

If the socket does not work after inspection of the correct wiring and relay connection, replace the unit with a similar model.

When returning products for investigation, please provide all information on the RMA form. Send defective products back to the manufacturer for repair or replacement. Normal wear and tear or external causes are excluded from warranty.



# V10 socket

## Ordering possibilities

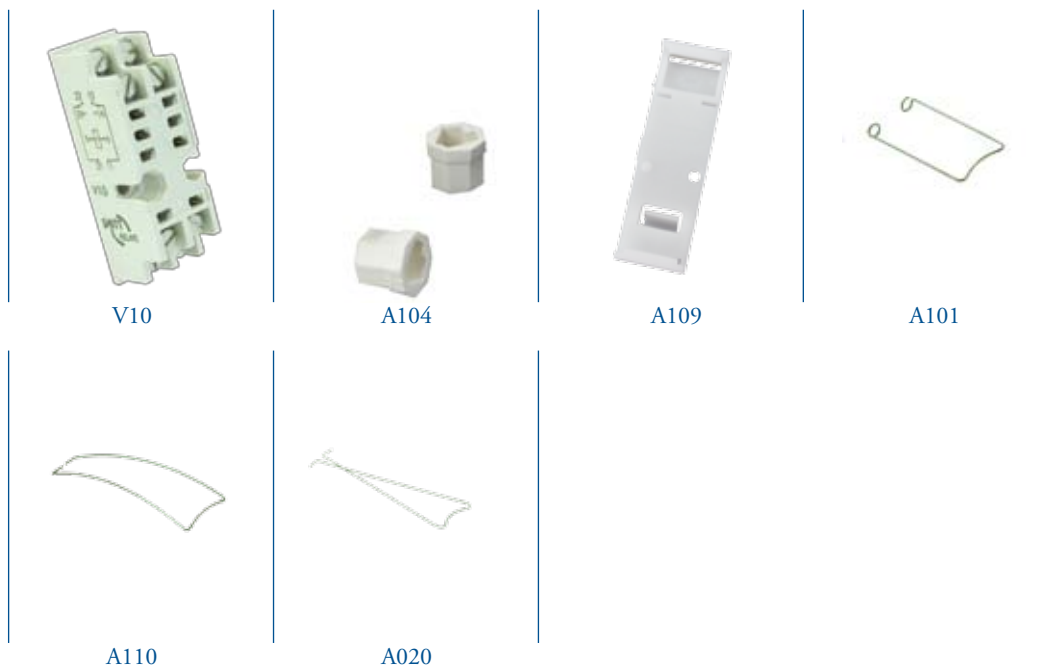

Article nr	Code	Description
338001000	V10	Screw terminal relay socket
378690100	A104	Key receptacle
339851100	A109	Rail clip
329851010	A101	Retaining clip (low, locked in socket without relay)
329851040	A110	Retaining clip (low, not locked in socket without relay)
329900003	A020	Retaining clip (high)





Mors Smitt France SAS

Tour Rosny 2, Avenue du Général de Gaulle,

F - 93118 Rosny-sous-Bois Cedex, France

T +33 (0)1 4812 1440, F +33 (0)1 4855 9001

E [sales@msrelais.com](mailto:sales@msrelais.com)

Mors Smitt Asia Ltd.

# 807, Billion Trade Centre, 31 Hung To Road

Kwun Tong, Kowloon, Hong Kong

T +852 2343 5555, F +852 2343 6555

E [info@morssmitt.hk](mailto:info@morssmitt.hk)

Mors Smitt B.V.

Vrieslantlaan 6, 3526 AA Utrecht,

Netherlands

T +31 (0)30 288 1311, F +31 (0)30 289 8816

E [sales@nieaf-smitt.nl](mailto:sales@nieaf-smitt.nl)

Mors Smitt Technologies inc.

420 Sackett Point Road

North Haven, Ct 06473, USA

T +1 (203) 287 8858, F +1 (888) 287 8852

E [mstechnologies@msrelais.com](mailto:mstechnologies@msrelais.com)

Mors Smitt UK Ltd

Doulton Road, Cradley Heath

West Midlands, B64 5QB, UK

T +44 (0) 1384 567 755, F +44 (0) 1384 567 710

E [info@morssmitt.co.uk](mailto:info@morssmitt.co.uk)