

TPBBU 400 relay - One-shot time

Datasheet



Description

The TPBBU 400 is one-shot time on pull-in or drop-out relay with 4 double make / double break C/O contacts (form Z). The delay is triggered by the up front of the command input and is fully programmable with a dip switch from 0.25 s to 63 min. The access to dip switch is available by removing time delay cover. This feature prohibits frivolous field time delay setting.

The plug-in design offers secure locking feature for maximum ease of maintenance (no wires need to be disconnected or other hardware removed for relay inspection or replacement). The resistance to impact and vibration is conform to standards in force for Railway Transported Equipment.

Positive mechanical keying of relay to socket is built into relay and socket during manufacture and terminal identifications are clearly marked on identification plate that is permanently attached to the relay.

The TPBBU 400 relay is pluggable in the following sockets: EA 102 B, EA 102 BF, EA 103 BF, EA 104 B, EA 104 BF, EA 105 BF, EA 112 BF.

Application

The TPBBU 400 timing relay is designed for heavy duty applications with a programmable timing function used for example in HVAC and lighting.

Features

- Delay on pull-in or drop-out relay
- Delay triggered by the up front of the command input
- Delay range from 0.25 s up to 63.75 min
- Time delay fully programmable by dip switch
- Status LED indicator
- Plug-in design with secure locking feature for maximum ease of maintenance
- 4 double make / double break C/O contacts (form Z), 12 A
- In standard with weld no transfer contacts
- -40 °C...85 °C operating temperature

Benefits

- Proven reliable in heavy duty application
- Weld no transfer
- Long life cycle
- Accurate timing selection finger safe
- Easy to maintain and replace
- Low life cycle cost
- No maintenance

Railway compliancy

- NF F 62-002 Rolling stock - Instantaneous relays contacts and sockets
- NF F 16-101/102 Fire behaviour - Railway rolling stock
- EN 50155 Railway application - electronic equipment used on rolling stock
- IEC 61373 Railway application - shock and vibration tests



TPBBU 400 relay

Technical specifications



Functional and connection diagrams

Timing diagram

Relay pin correspondence

(rear view of relay shown)

Example: KT keying

Connection diagram

Dip switch setting

- Set DS 1 to 8 in ON or OFF position
- The final time delay is the sum of each individual ON value given in second if DS 9 is ON or in minute if DS 9 is OFF
- DS 10 selects pull-in or drop-out

DS no	Range 1 DS 9 = ON	Range 2 DS 9 = OFF
DS 1	ON 0.25 s	ON 0.25 min
DS 2	ON 0.50 s	ON 0.50 min
DS 3	ON 1 s	ON 1 min
DS 4	ON 2 s	ON 2 min
DS 5	ON 4 s	ON 4 min
DS 6	ON 8 s	ON 8 min
DS 7	ON 16 s	ON 16 min
DS 8	ON 32 s	ON 32 min
DS 9	ON Range 1	OFF Range 2
DS 10	ON Pull-in	ON Pull-in
DS 10	OFF Drop-out	OFF Drop-out

Example: The sample dip switch above is set to 22.5 s with delay on drop-out



TPBBU 400 relay

Technical specifications

Time characteristics

Time function	Delay on pull-in or drop-out (selection by dip switch)
Total time delay range	0.25 s...63.75 min
Time delay adjustment	Fixed after setting the dip switch (access available by removing relay cover)
Adjustment / repeatability accuracy	< 2% (td > 5 s), < 10% (td = 0.25 s...5 s), 0.1% (td = time delay) (adjustment must be accomplished power off)

Coil data

Keying	U _{nom}	U _{operating}	P _{nom}	R coil (Ω) ⁽¹⁾	L/R (ms) ⁽²⁾
GT	24 VDC	16 / 33 VDC	3 W	185	30 ms
HT	36 VDC	25 / 45 VDC	3 W	475	30 ms
JT	48 VDC	33 / 60 VDC	3 W	750	30 ms
KT	72 VDC	48 / 90 VDC	3 W	1700	30 ms
MT	96 VDC	65 / 120 VDC	3 W	3000	30 ms
LT	110 VDC	75 / 138 VDC	3 W	4000	30 ms

(1) Coil resistance tol.: ± 8% at 20 °C

(2) Valid for closed relay

Contact data - standard version (Ag contacts)

Nominal current	12 A resistive
Nominal breaking capacity and life	3 A at 72 VDC L/R : 0 ms Electrical life: 5x10 ⁶ op.
	1 A at 72 VDC L/R: 30 ms Electrical life: 2.5x10 ⁶ op.
	3 A at 220 VAC, 50 Hz cos φ = 1 ms Electrical life: 2.5x10 ⁶ op.
	Lamp filament circuit: 200 W at 72 VDC Electrical life: 5x10 ⁵ op.
Contact overload withstand	At 24 VDC: 200 A at L/R = 0 for 10 ms (10 operations at the rate of 1 operations per minute)
Contact closures time	Pick-up N/O < 55 ms Drop-out* time N/C: < 25 ms
Contact opening time	Pick-up N/C < 50 ms Drop-out* time N/O: < 15 ms
Minimum contact continuity	20mA at 24 VDC
Number of contacts	4 double make / double break contacts (form Z)
Contact material	Hard silver overlay laminated to copper
Contact resistance, initial	10 mΩ max at 5 A
Contact resistance, end of life	40 mΩ max at 5 A



TPBBU 400 relay

Technical specifications

Contact design

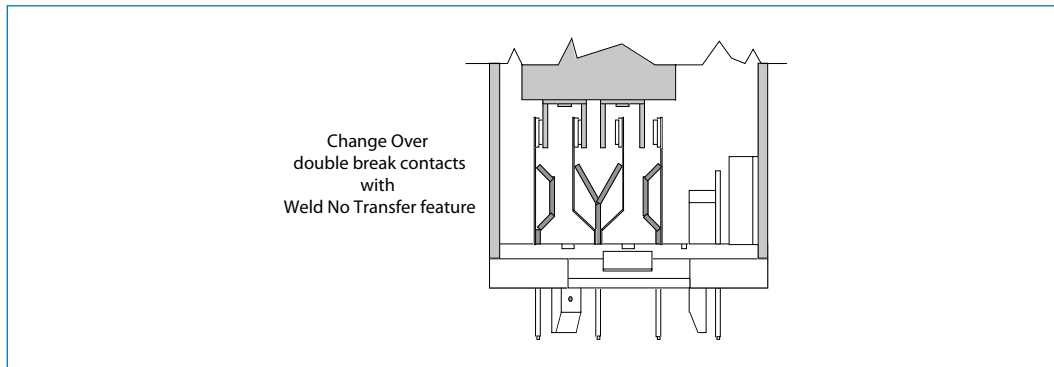

Electrical characteristics

Dielectric strength	2000 VAC, 1 min between contacts 2600 VAC, 1 min between contacts, coil and frame
Insulation resistance	≥ 1000 MΩ at 500 VDC

Mechanical & environmental characteristics

Vibration	NF F 62-002 The tests are conducted in the X, Y , Z planes at frequency between 10 & 150 cycles (sinusoidal) at 2 g
Shock	NF F 62-002 Tests are applied in both directions in the X, Y & Z planes. Then successive shocks are administered consisting of the positive component of sinusoidal with a value of 30 g, 11 ms Other vibration and shock tests can be performed on request
Mechanical life	100 x 10 ⁶ operations
Weight	400 g (15.87 ounces)
Temperature	-40 °C...+80 °C
Humidity	93% RH, 40° C for 4 days
Salt mist	5% NaCl, 35° C for 4 days
Protection	IP40 (timing relay on socket)
Fire & smoke	Materials: Polycarbonate (cover) / polyester melamine (base) Note: These materials have been tested for fire propagation and smoke emission according standards NF F 16-101, NF F 16-102.

TPBBU 400 relay

Technical specifications

Dimensions (mm)

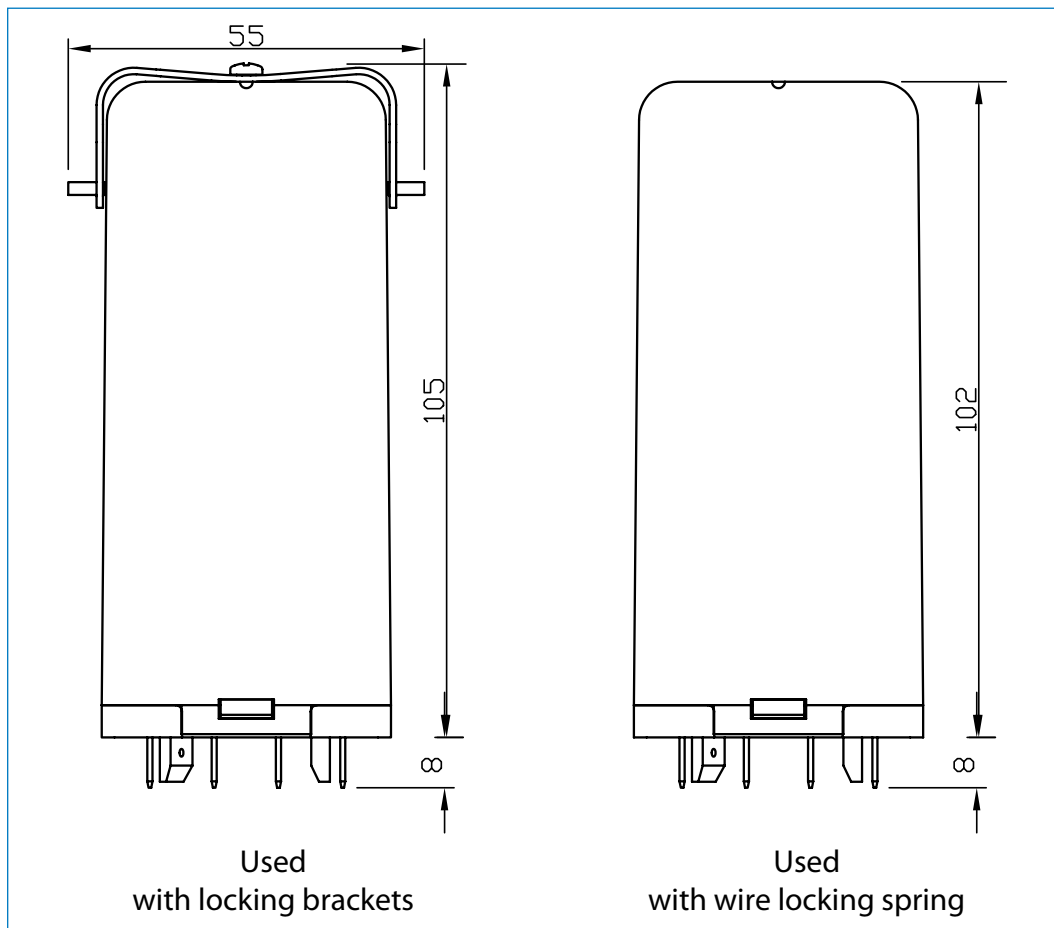

TPBBU 400 relay

Technical specifications

Dynamic relay selection curve No 1

AC Current breaking capacity versus life expectancy in millions of cycles.

Rate of contacts opening and closing = 1200 operations per hour.

Curves shown for resistive load (Power Factor = 1).

Curve	1	2	3	4
VAC	220	125	48	24

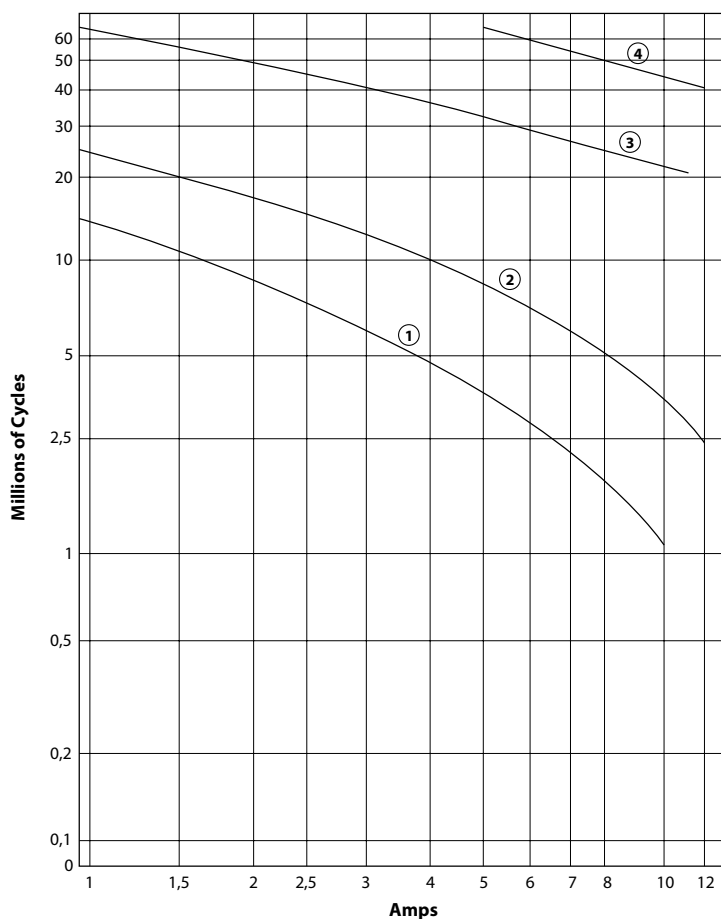

TPBBU 400 relay

Technical specifications

Dynamic relay selection curve No 2

DC Current breaking capacity versus life expectancy in millions of cycles.

Rate of contacts opening and closing = 1200 operations per hour.

Curves shown for inductive load -

—— L/R= 20 ms continuous current

- - - - L/R= 40 ms continuous current

* By connecting 2 contacts in series, DC current breaking capacity increases by 50 %

Curves	1-3	2-4	5-7	6-8
VDC	220	125	48	24

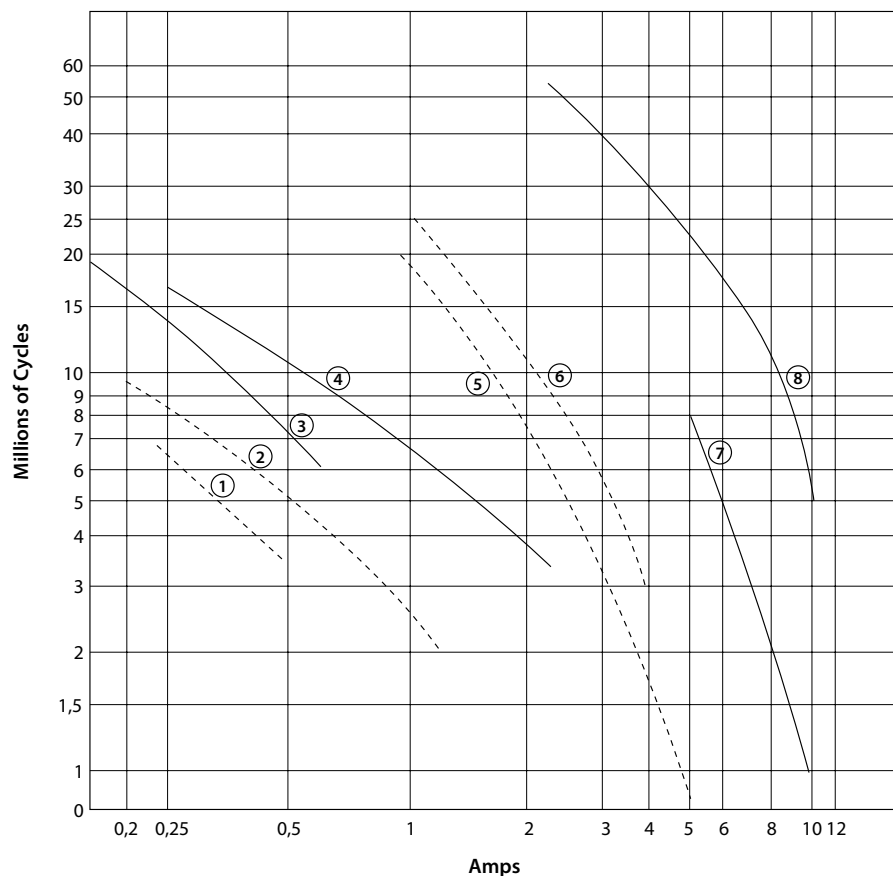

TPBBU 400 relay

Technical specifications

Dynamic relay selection curve No 3

DC Current breaking capacity versus life expectancy in millions of cycles.

Rate of contacts opening and closing = 1200 operations per hour.

Curves shown for resistive load (L/R = 0). Continuous current.

* By connecting 2 contacts in series, DC current breaking capacity increases by 50 %

Curve	1	2	3	4
VDC	220	125	48	24

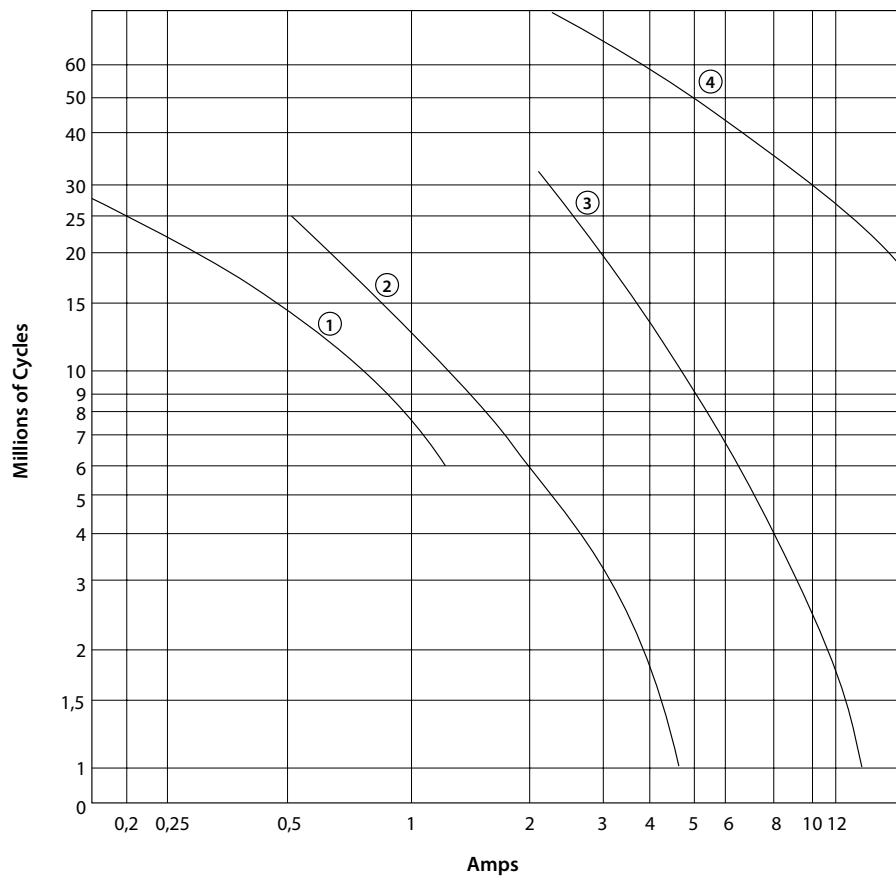

TPBBU 400 relay

Technical specifications

Dynamic relay selection curve No 4

Maximum contact breaking capacity versus voltage for a given L/R.

Rate of contacts opening and closing = 600 operations per hour.

Curves shown for resistive load (L/R=0) and inductive loads. Continuous current.

Life expectancy: 2 Millions of Cycles

Curve	1	2	3	4	5	6
L/R=	0ms	15ms	20ms	40ms	60ms	100ms

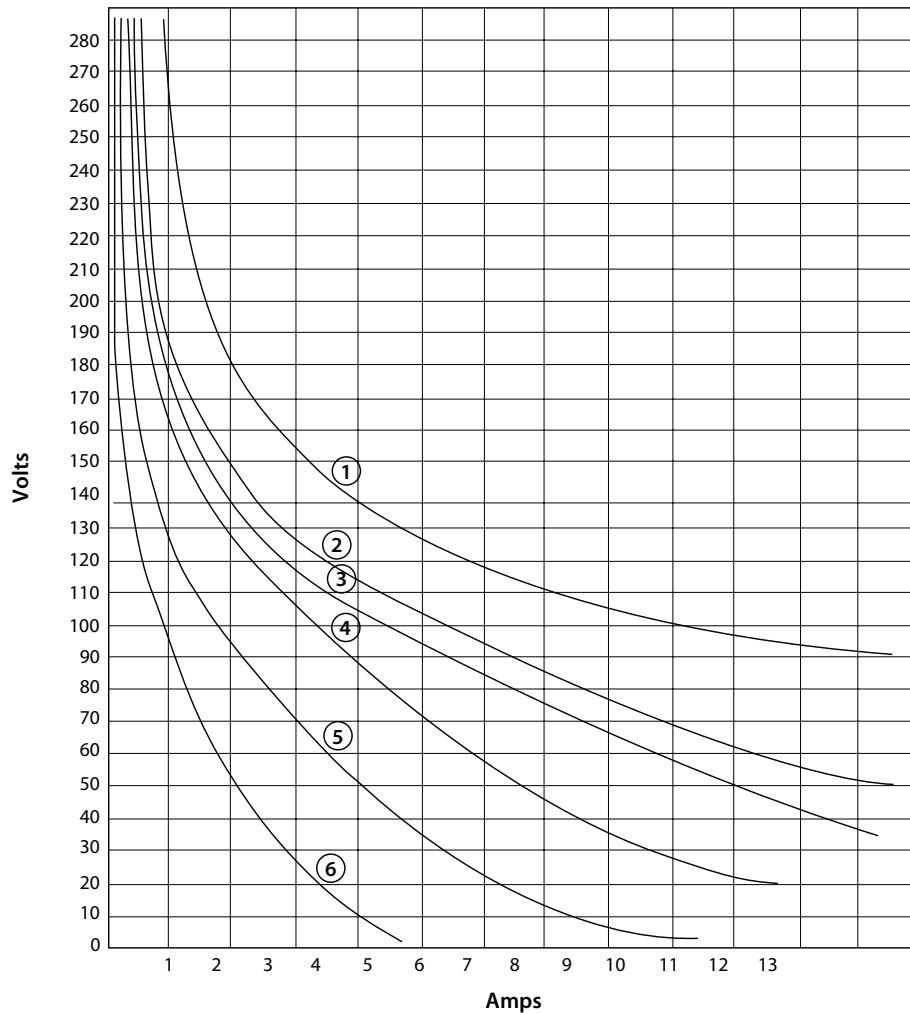

TPBBU 400 relay

Technical specifications

Dynamic relay selection curve No 5

Maximum power interruption versus load time constant (L/R) for a given voltage.
Curves shown for resistive loads. $I = P/V$.

Curve	1	2	3	4	5
VDC	220	125	72	48	24

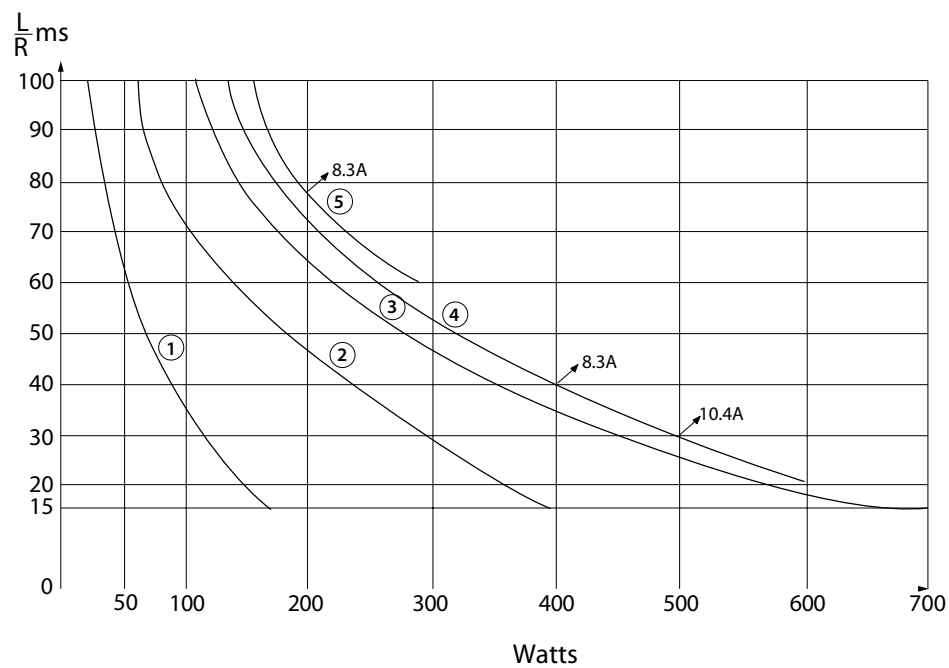

TPBBU 400 relay

Technical specifications

Dynamic relay selection curve No 6

AC Current breaking capacity versus life expectancy in millions of cycles.

Rate of contacts opening and closing = 1200 operations per hour.

Values shown for inductive loads -

- Cos ϕ = 0.7
- - - Cos ϕ = 0.5
- - - - Cos ϕ = 0.3

Curves	1,3 &5	2,4 &7	6,9 &10	8,11 &12
VAC	220	125	48	24

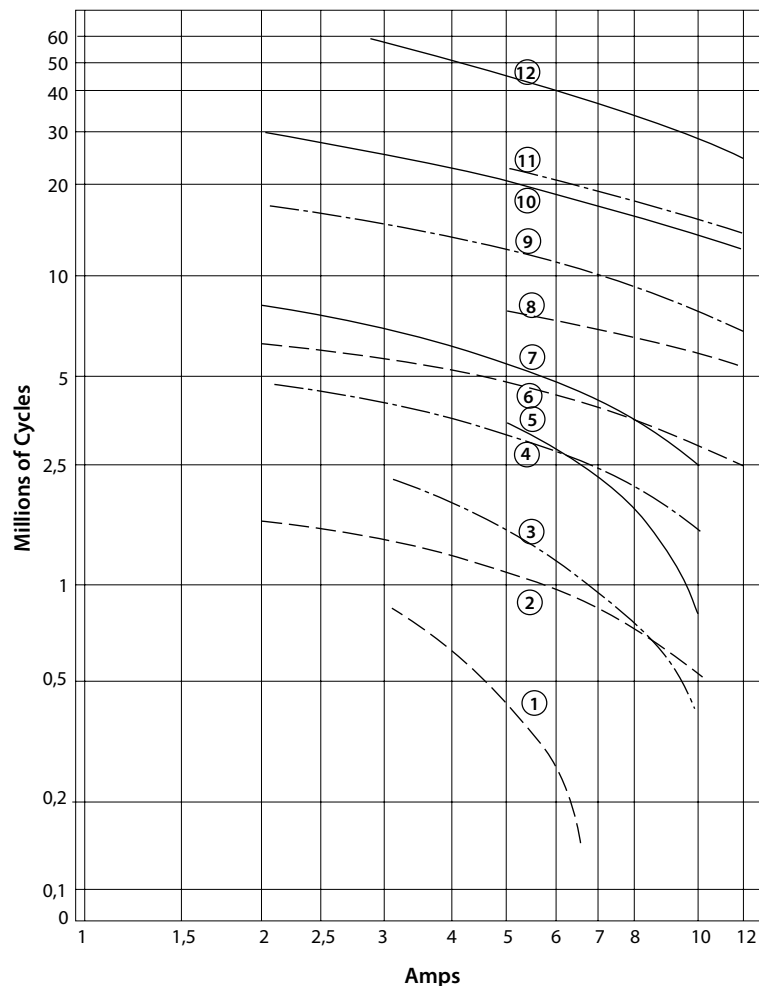

TPBBU 400 relay

Mounting possibilities / sockets

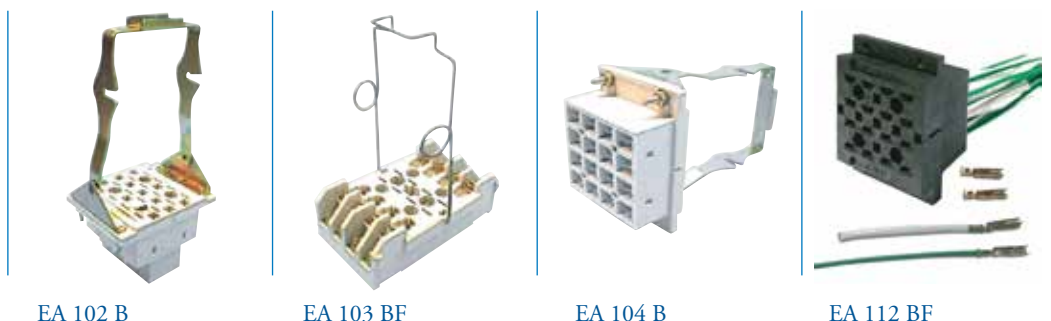

Panel/flush mounting

EA 102 B	Locking bracket (905843), rear connection, double Faston 5 mm
EA 102 BF	Wire locking spring (926853), rear connection, single Faston 5 mm
EA 104 B	Locking bracket (905843), rear connection, single Faston 5 x 0.8 mm
EA 104 BF	Wire locking spring (926853), rear connection, single Faston 5 x 0.8 mm
EA 112 BF	Wire locking spring (926853), rear connection, crimp contact

Surface/wall mounting

EA 103 BF*	Wire locking spring (926853), front connection, M3 screw 6.5 mm ring terminals (2,5 mm ²)
EA 105 BF*	Wire locking spring (926853), front connection, single Faston 5 mm









* Mounting possibility on 35 mm rail EN 50022 by adding suffix D to the part number (see socket datasheet)

Note: Keying of relay to socket can be specified by adding the keying letters in the part number. See all details in the related socket datasheet.

TPBBU 400 relay

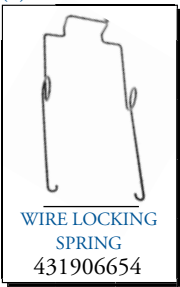
Spare parts

Spare parts - order part numbers

(1)  LOCKING BRACKET 905846	(1)  SCREW FOR BRACKET C927210	(1)  METAL STRAP (2) P928060	(1)  METAL STRAP (4) P928061
(1)  WIRE LOCKING SPRING 431906654	(1)  ROUND PLASTIC PLUGS 414928005	(2)  HEX. PLASTIC KEYS 414905678	(3)  LOCK PINS ASSY 2 SCREWS 906364 212903020

(1) Parts only for socket
 (2) Parts for relay and socket
 (3) Parts only for relay



TPBBU 400 relay

Instructions

Installation

Install socket and connect wiring correctly according identification to terminals. Plug relay into socket. Reverse installation into socket not possible due to mechanical blocking by snap-lock.

Don't reverse polarity of coil connection. Relays can be mounted (tightly) next to each other and in any attitude.

Warning! Never use silicon near by relays

Operation

Before operating always apply voltage to coil to check correct operation.

Long term storage may corrode the silver on the relay pins. Just by plugging the relay into the socket, the female bifurcated receivers will automatically clean the corrosion on the pins and guarantee a good connection.

Do not use the relay in places with flammable gas as the arc generated from switching could ignite gasses.

Maintenance

Correct operation of relay can easily be checked as transparent cover gives good visibility on the moving contacts. When the relay doesn't seem to operate correct, please check presence of coil voltage. Use a multimeter. If LED is used, coil presence should be indicated. If coil voltage is present, but the relay doesn't work, a short circuit of suppression diode is possible (The coil connection was reversed). If relay doesn't work after inspection, please replace relay unit by a similar model. Send defective relay back to manufacturer. Normal wear and tear excluded.



TPBBU 400 relay

Ordering scheme

Configuration:

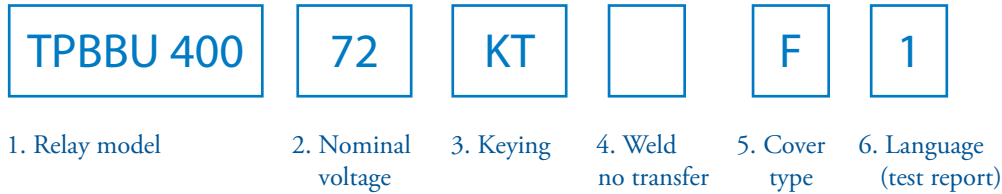

This example represents a **TPBBU 400 72 KT F 1**.

Description: TPBBU series relay, Unom: 72 VDC, keying KT, relay cover for wire locking spring, test report in English

1. Relay model

TPBBU 200

2 & 3. Nominal voltage and keying

24 GT	24 VDC
36 HT	36 VDC
48 JT	48 VDC
72 KT	72 VDC
96 MT	96 VDC
110 LT	110 VDC

4. Weld no transfer

Weld no transfer

5. Relay cover type

-	Relay cover with lock pins
F	Relay cover for wire locking spring

6. Language on test report

-	French
1	English
2	Spanish





DS-TPBBU 400 relay-V2.0 May 2013



www.morssmitt.com



Mors Smitt France SAS

Tour Rosny 2, Avenue du Général de Gaulle,

F - 93118 Rosny-sous-Bois Cedex, FRANCE

T +33 (0)1 4812 1440, F +33 (0)1 4855 9001

E sales@msrelais.com

Mors Smitt Asia Ltd.

807, Billion Trade Centre, 31 Hung To Road

Kwun Tong, Kowloon, HONG KONG SAR

T +852 2343 5555, F +852 2343 6555

E info@morssmitt.hk

Mors Smitt B.V.

Vrieslantlaan 6, 3526 AA Utrecht,

NETHERLANDS

T +31 (0)30 288 1311, F +31 (0)30 289 8816

E sales@nieaf-smitt.nl

Mors Smitt Technologies Inc.

420 Sackett Point Road

North Haven, CT 06473, USA

T +1 (203) 287 8858, F +1 (888) 287 8852

E mstechnologies@msrelais.com

Mors Smitt UK Ltd.

Doulton Road, Cradley Heath

West Midlands, B64 5QB, UK

T +44 (0)1384 567 755, F +44 (0)1384 567 710

E info@morssmitt.co.uk

© Copyright 2013

All rights reserved. Nothing from this edition may be multiplied, or made public in any form or manner, either electronically, mechanically, by photocopying, recording, or in any manner, without prior written consent from Mors Smitt. This also applies to accompanying drawings and diagrams. Due to a policy of continuous development Mors Smitt reserves the right to alter the equipment specification and description outlined in this datasheet without prior notice and no part of this publication shall be deemed to be part of any contract for the equipment unless specifically referred to as an inclusion within such contract.