

T2CBBU 400 relay - Asymmetrical flasher, Datasheet 4 contacts



Description

The T2CBBU 400 is an asymmetrical flasher relay with 4 double make / double break C/O contacts (form Z). The first period is adjusted 0.1 s...1.5 s and second period 1 s...15 s. Time delay is achieved by combination of relay dip switch. The access to dip switch is available by removing time delay cover. This feature prohibits frivolous field time delay setting. Timing can be also be factory set on order.

The plug-in design offers secure locking feature for maximum ease of maintenance (no wires need to be disconnected or other hardware removed for relay inspection or replacement). The resistance to impact and vibration is conform to standards in force for Railway Transported Equipment.

Positive mechanical keying of relay to socket is built into relay and socket during manufacture and terminal identifications are clearly marked on identification plate that is permanently attached to the relay

The T2CBBU 400 relay is pluggable in the following sockets: EA 102 B, EA 102 BF, EA 103 BF, EA 104 B, EA 104 BF, EA 105 BF, EA 112 BF.

Application

The T2CBBU 400 timing relay is designed for heavy duty applications with a programmable timing function used for example in lighting.

Features

- 2 flashing periods programmable
- 1st period 0.1 s...1.5 s and 2nd period 1 s...15 s
- Time delay is achieved by combination of relay dip switch
- Status LED indicator
- Plug-in design with secure locking feature for maximum ease of maintenance
- 4 double make / double break C/O contacts (form Z), 12 A
- Weld no transfer contacts standard
- Contact life (mechanical) of 100 million cycles
- -40 °C...+85 °C operating temperature

Benefits

- Proven reliable in heavy duty application
- Weld no transfer
- Long life cycle
- Accurate timing selection finger safe
- Easy to maintain and replace
- Low life cycle cost
- No maintenance

Railway compliancy

- NF F 62-002 Rolling stock - Instantaneous relays contacts and sockets
- NF F 16-101/102 Fire behaviour - Railway rolling stock
- EN 50155 Railway application - Electronic equipment used on rolling stock
- IEC 61373 Railway application - shock and vibration tests



T2CBBU 400 relay

Technical specifications



Functional and connection diagrams

Timing diagram	Relay pin correspondence
<p style="text-align: center;">Asymmetrical flasher</p>	<p style="text-align: center;">Relay pin correspondence</p> <p style="text-align: center;">Example: KP keying</p>

Connection diagram	Dip switch setting																																				
	<ul style="list-style-type: none"> - DS 1 to 4: period T1 - DS 5 to 8: period T2 - DS 9: ON period T1 long, OFF period T1 short - DS 10: ON finish the cycles after command cut off; OFF immediate stop after command cut off <table border="1"> <thead> <tr> <th>DS no</th> <th>Range 1 DS 9 = ON</th> <th>Range 2 DS 9 = OFF</th> </tr> </thead> <tbody> <tr><td>DS 1</td><td>ON 1 s</td><td>ON 0.1 s</td></tr> <tr><td>DS 2</td><td>ON 2 s</td><td>ON 0.2 s</td></tr> <tr><td>DS 3</td><td>ON 4 s</td><td>ON 0.4 s</td></tr> <tr><td>DS 4</td><td>ON 8 s</td><td>ON 0.8 s</td></tr> <tr><td>DS 5</td><td>ON 1 s</td><td>ON 0.5 s</td></tr> <tr><td>DS 6</td><td>ON 2 s</td><td>ON 1 s</td></tr> <tr><td>DS 7</td><td>ON 4 s</td><td>ON 2 s</td></tr> <tr><td>DS 8</td><td>ON 8 s</td><td>ON 4 s</td></tr> <tr><td>DS 9</td><td>ON T1 long</td><td>OFF T1 short</td></tr> <tr><td>DS 10</td><td>ON see above</td><td>ON see above</td></tr> <tr><td>DS 10</td><td>OFF see above</td><td>OFF see above</td></tr> </tbody> </table> <p>Example: The sample dip switch above is set to T1 of 2 s and T2 of 5 s</p>	DS no	Range 1 DS 9 = ON	Range 2 DS 9 = OFF	DS 1	ON 1 s	ON 0.1 s	DS 2	ON 2 s	ON 0.2 s	DS 3	ON 4 s	ON 0.4 s	DS 4	ON 8 s	ON 0.8 s	DS 5	ON 1 s	ON 0.5 s	DS 6	ON 2 s	ON 1 s	DS 7	ON 4 s	ON 2 s	DS 8	ON 8 s	ON 4 s	DS 9	ON T1 long	OFF T1 short	DS 10	ON see above	ON see above	DS 10	OFF see above	OFF see above
DS no	Range 1 DS 9 = ON	Range 2 DS 9 = OFF																																			
DS 1	ON 1 s	ON 0.1 s																																			
DS 2	ON 2 s	ON 0.2 s																																			
DS 3	ON 4 s	ON 0.4 s																																			
DS 4	ON 8 s	ON 0.8 s																																			
DS 5	ON 1 s	ON 0.5 s																																			
DS 6	ON 2 s	ON 1 s																																			
DS 7	ON 4 s	ON 2 s																																			
DS 8	ON 8 s	ON 4 s																																			
DS 9	ON T1 long	OFF T1 short																																			
DS 10	ON see above	ON see above																																			
DS 10	OFF see above	OFF see above																																			



T2CBBU 400 relay

Technical specifications

Timing characteristics

Time function	Asymmetrical flashing (selection by dip switch)
Total time delay range	0.15 s...15 s
Time delay adjustment	Fixed after setting the dip switch (access available by removing relay cover)
Adjustment / repeatability accuracy	< 2% (td > 5 s), < 10% (td = 0.25 s up to 5 s) / < 0.1% (td = time delay) (Adjustment with power off)

Coil data

Keying	U _{nom} (VDC)	U _{operating} (VDC)	P _{nom} (W)	R coil (Ω) ⁽¹⁾	L/R (ms) ⁽²⁾
GO	12	8 / 16	3	40	30
XX	24	16 / 33	3	185	30
XX	36	25 / 45	3	475	30
XX	48	33 / 60	3	750	30
KO	72	48 / 90	3	1700	30
XX	96	65 / 120	3	3000	30
XX	110	75 / 138	3	4000	30

(1) Coil resistance tol.: ± 8% at 20 °C

(2) Valid for closed relay

XX = to be defined

Contact data

Nominal current	12 A resistive		
Nominal breaking capacity and life	3 A at 72 VDC	L/R : 0 ms	Electrical life: 5 x 10 ⁶ op.
	1 A at 72 VDC	L/R: 30 ms	Electrical life: 2.5 x 10 ⁶ op.
	3 A at 220 VAC 50 Hz	cosØ=1	Electrical life: 2.5 x 10 ⁶ op.
	Lamp filament circuit: 200 W at 72 VDC		Electrical life: 5 x 10 ⁵ op.
Contact overload withstand	At 24 VDC: 200 A at L/R = 0 for 10 ms (10 operations at the rate of 1 operation per minute)		
Contact closure time	Pick-up time N/O < 55 ms	Drop-out* time N/C < 25 ms	
Contact opening time	Pick-up time N/C < 50 ms	Drop-out* time N/O < 15 ms	
Minimum contact continuity	20 mA at 24 VDC		
Number of contacts	4 double make / double break contacts (form Z)		
Contact material	Hard silver overlay laminated to copper		
Contact resistance	initial	10 mΩ max at 5 A	
	end of life	40 mΩ max at 5 A	



T2CBBU 400 relay

Technical specifications

Contact design

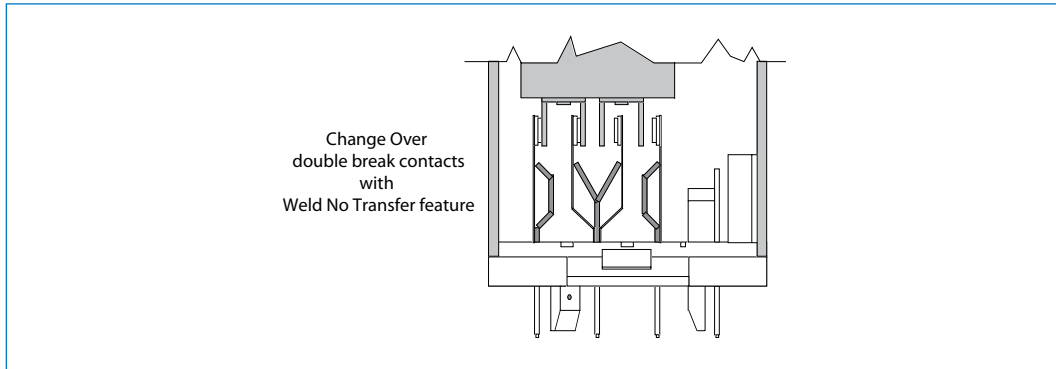

Electrical characteristics

Dielectric strength	2000 VAC, 1 min between contacts 2600 VAC, 1 min between contacts, coil and frame
Insulation resistance	≥ 1000 MΩ at 500 VDC

Mechanical & environmental characteristics

Vibration	NF F 62-002 The tests are conducted in the X, Y , Z planes at frequency between 10 & 150 cycles (sinusoidal) at 2 g IEC 61373
Shock	NF F 62-002 Tests are applied in both directions in the X, Y & Z planes. Then successive shocks are administered consisting of the positive component of sinusoidal with a value of 30 g, 11 ms IEC 61373 Other vibration and shock tests can be performed on request
Mechanical life	> 100 x 10 ⁶ operations
Weight	450 g (15.8 ounces)
Temperature	-40 °C...+85 °C
Humidity	93% RH, 40° C for 4 days
Salt mist	5% NaCl, 35° C for 4 days
Protection	IP40 (relay on socket)
Fire & smoke	Materials: Polycarbonate (cover) / polyester melamine (base) Note: These materials have been tested for fire propagation and smoke emission according standards NF F 16-101, NF F 16-102. They have been approved for use on the English/French train channel shuttle



T2CBBU 400 relay

Technical specifications

Dimensions (mm)

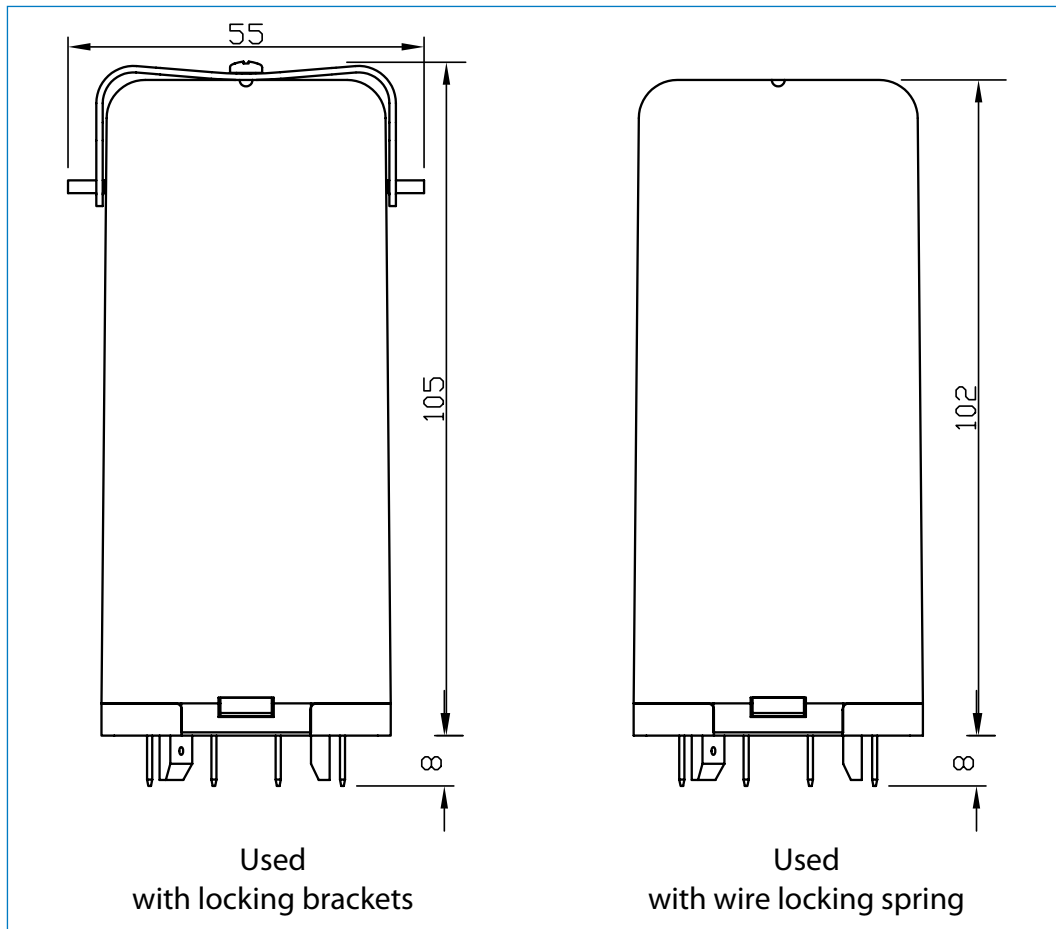

T2CBBU 400 relay

Technical specifications

Dynamic relay selection curve No 1

AC Current breaking capacity versus life expectancy in millions of cycles.

Rate of contacts opening and closing = 1200 operations per hour.

Curves shown for resistive load (Power Factor = 1).

Curve	1	2	3	4
VAC	220	125	48	24

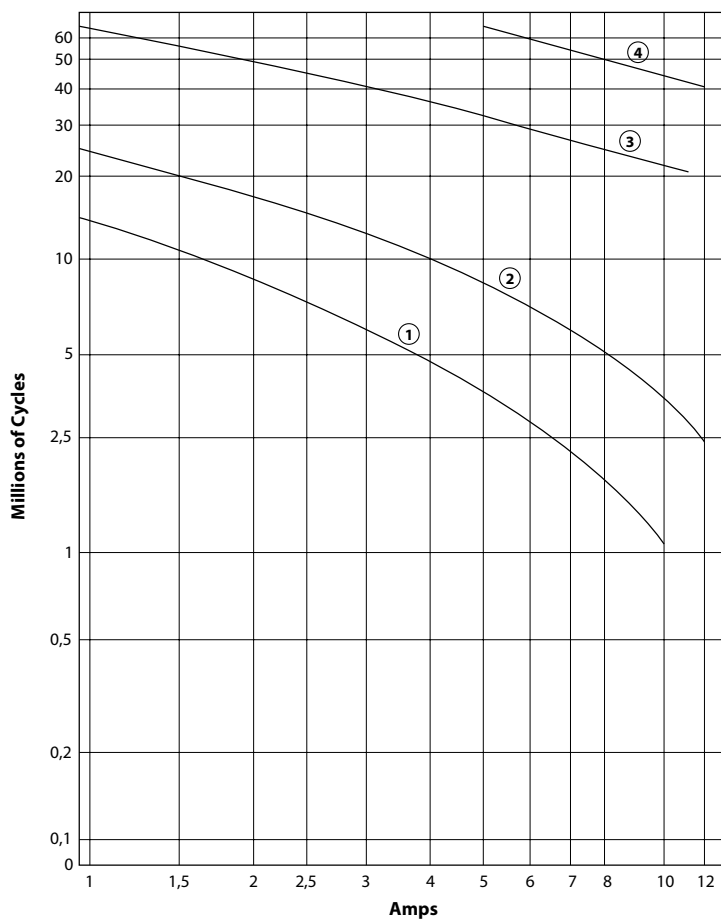

T2CBBU 400 relay

Technical specifications

Dynamic relay selection curve No 2

DC Current breaking capacity versus life expectancy in millions of cycles.

Rate of contacts opening and closing = 1200 operations per hour.

Curves shown for inductive load -

—— L/R= 20 ms continuous current

- - - - L/R= 40 ms continuous current

* By connecting 2 contacts in series, DC current breaking capacity increases by 50 %

Curves	1-3	2-4	5-7	6-8
VDC	220	125	48	24

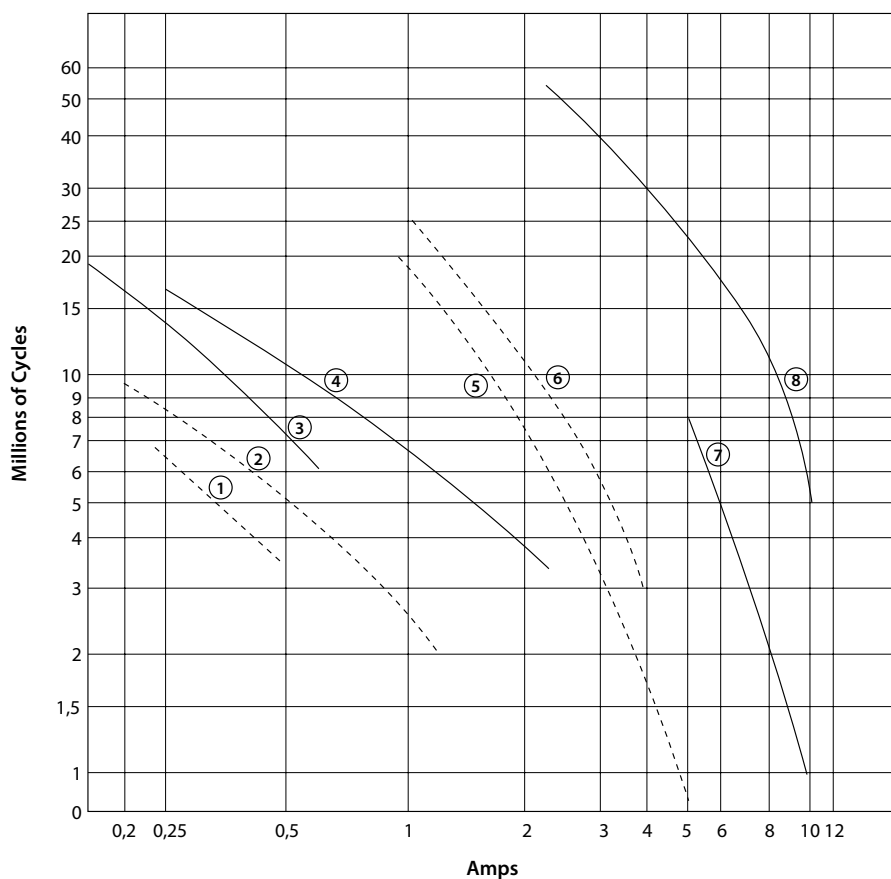

T2CBBU 400 relay

Technical specifications

Dynamic relay selection curve No 3

DC Current breaking capacity versus life expectancy in millions of cycles.

Rate of contacts opening and closing = 1200 operations per hour.

Curves shown for resistive load (L/R = 0). Continuous current.

* By connecting 2 contacts in series, DC current breaking capacity increases by 50 %

Curve	1	2	3	4
VDC	220	125	48	24

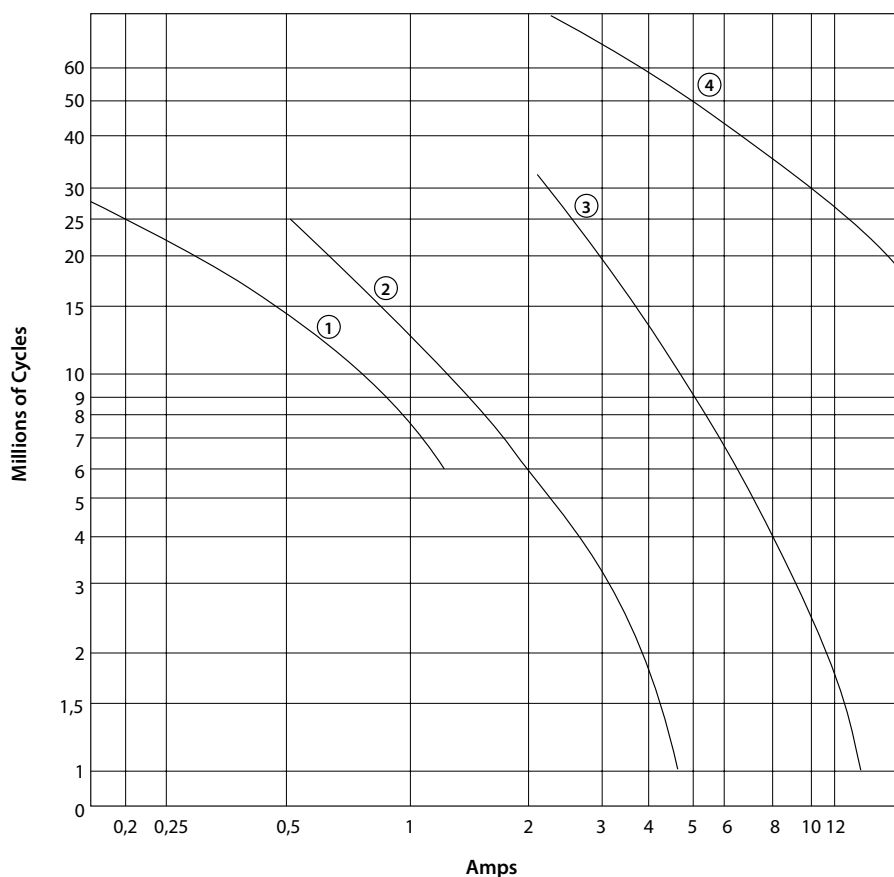

T2CBBU 400 relay

Technical specifications

Dynamic relay selection curve No 4

Maximum contact breaking capacity versus voltage for a given L/R.

Rate of contacts opening and closing = 600 operations per hour.

Curves shown for resistive load (L/R=0) and inductive loads. Continuous current.

Life expectancy: 2 Millions of Cycles

Curve	1	2	3	4	5	6
L/R=	0ms	15ms	20ms	40ms	60ms	100ms

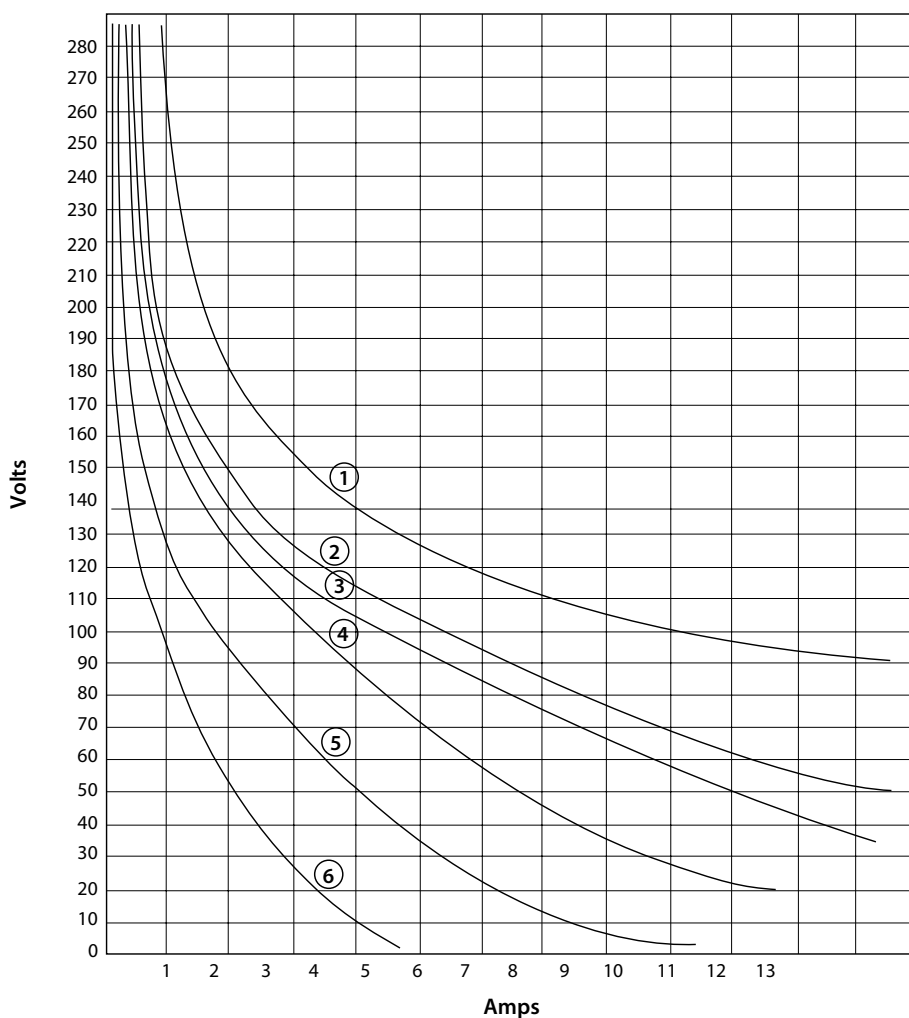

T2CBBU 400 relay

Technical specifications

Dynamic relay selection curve No 5

Maximum power interruption versus load time constant (L/R) for a given voltage.
Curves shown for resistive loads. $I = P/V$.

Curve	1	2	3	4	5
VDC	220	125	72	48	24

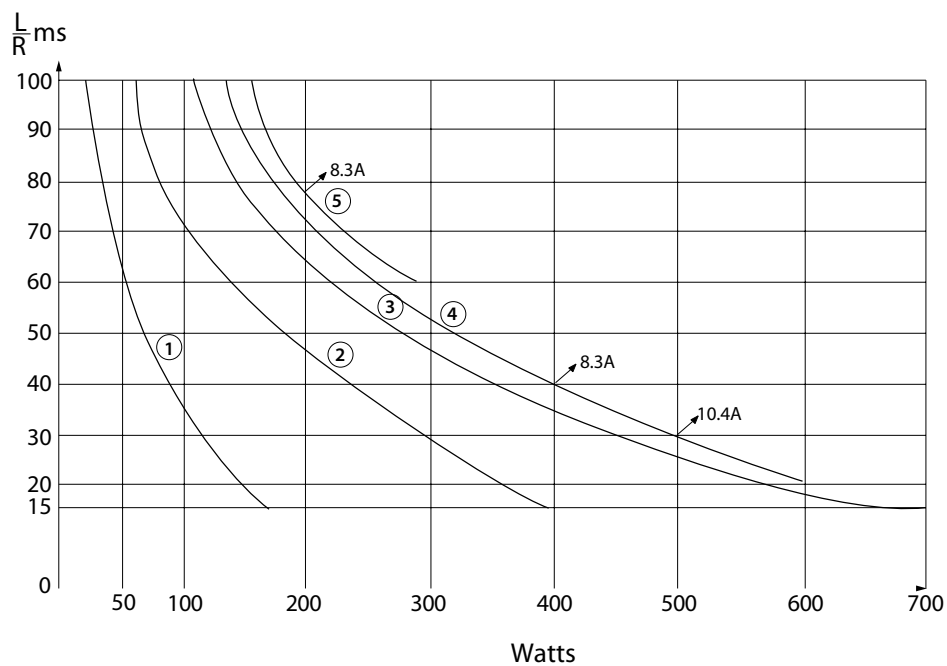

T2CBBU 400 relay

Technical specifications

Dynamic relay selection curve No 6

AC Current breaking capacity versus life expectancy in millions of cycles.

Rate of contacts opening and closing = 1200 operations per hour.

Values shown for inductive loads -

——— Cos ϕ = 0.7

- - - - Cos ϕ = 0.5

- - - - Cos ϕ = 0.3

Curves	1,3 &5	2,4 &7	6,9 &10	8,11 &12
VAC	220	125	48	24

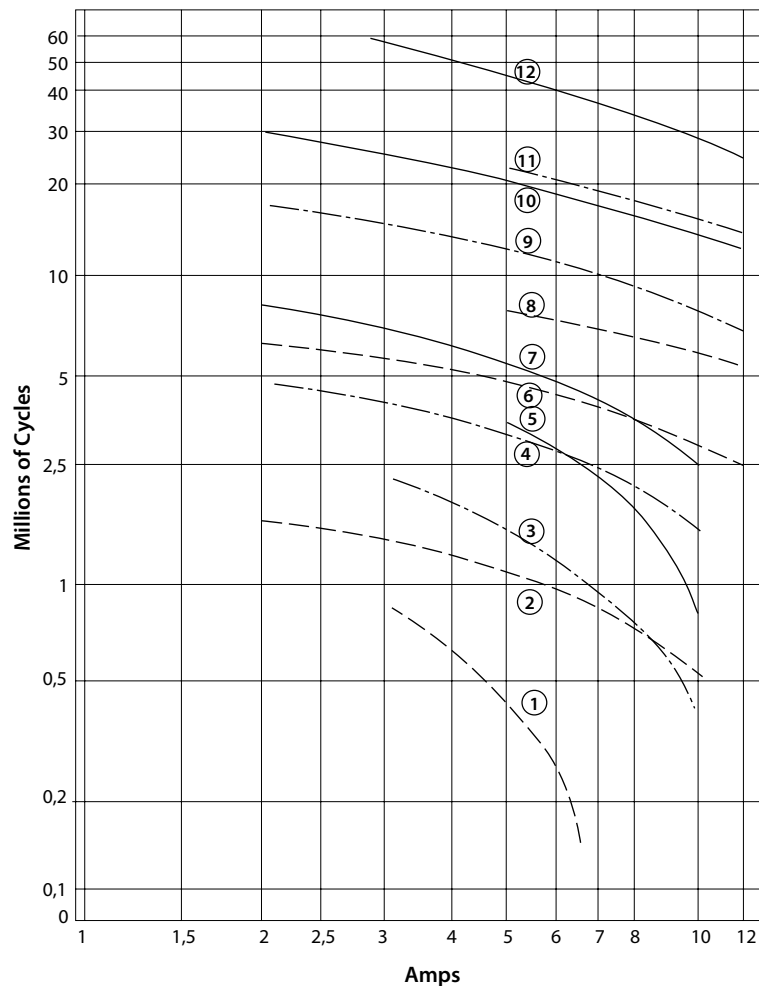

T2CBBU 400 relay

Mounting possibilities / sockets

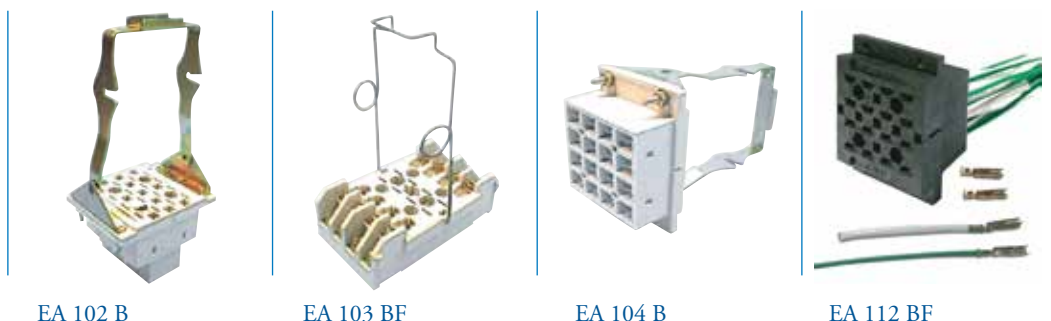

Panel/flush mounting

EA 102 B	Locking bracket (905843), rear connection, double Faston 5 mm
EA 102 BF	Wire locking spring (926853), rear connection, single Faston 5 mm
EA 104 B	Locking bracket (905843), rear connection, single Faston 5 x 0.8 mm
EA 104 BF	Wire locking spring (926853), rear connection, single Faston 5 x 0.8 mm
EA 112 BF	Wire locking spring (926853), rear connection, crimp contact

Surface/wall mounting

EA 103 BF*	Wire locking spring (926853), front connection, M3 screw 6.5 mm ring terminals (2,5 mm ²)
EA 105 BF*	Wire locking spring (926853), front connection, single Faston 5 mm







* Mounting possibility on 35 mm rail EN 50022 by adding suffix D to the part number (see socket datasheet)

Note: Keying of relay to socket can be specified by adding the keying letters in the part number. See all details in the related socket datasheet.

T2CBBU 400 relay

Spare parts

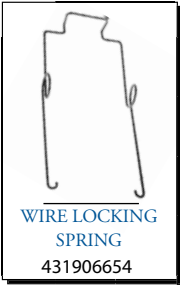
Spare parts - order part numbers

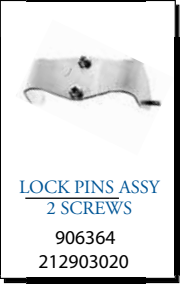
(1)  LOCKING BRACKET 905846	(1)  SCREW FOR BRACKET C927210	(1)  METAL STRAP (2) P928060	(1)  METAL STRAP (4) P928061
(1)  WIRE LOCKING SPRING 431906654	(1)  ROUND PLASTIC PLUGS 414928005	(2)  HEX. PLASTIC KEYS 414905678	(3)  LOCK PINS ASSY 2 SCREWS 906364 212903020

(1) Parts only for socket
 (2) Parts for relay and socket
 (3) Parts only for relay



T2CBBU 400 relay

Instructions

Installation

Install socket and connect wiring correctly according identification to terminals. Plug relay into socket. Reverse installation into socket not possible due to mechanical blocking by snap-lock.

Don't reverse polarity of coil connection. Relays can be mounted (tightly) next to each other and in any attitude.

Warning! Never use silicon near by relays

Operation

Before operating always apply voltage to coil to check correct operation.

Long term storage may corrode the silver on the relay pins. Just by plugging the relay into the socket, the female bifurcated receivers will automatically clean the corrosion on the pins and guarantee a good connection.

Do not use the relay in places with flammable gas as the arc generated from switching could ignite gasses.

Maintenance

Correct operation of relay can easily be checked as transparent cover gives good visibility on the moving contacts. When the relay doesn't seem to operate correct, please check presence of coil voltage. Use a multimeter. If LED is used, coil presence should be indicated. If coil voltage is present, but the relay doesn't work, a short circuit of suppression diode is possible (The coil connection was reversed). If relay doesn't work after inspection, please replace relay unit by a similar model. Send defective relay back to manufacturer. Normal wear and tear excluded.



T2CBBU 400 relay

Ordering scheme

Configuration:



This example represents a **T2CBBU 400 72 KO F 1**.

Description: T2CBBU 400 relay, U_{nom} : 72 VDC, keying KO, relay cover for wire locking spring, test report in English

1. Relay model

T2CBBU 400

2 & 3. Nominal voltage and keying

24 GO	24 VDC
36 xx	36 VDC
48 xx	48 VDC
72 KO	72 VDC
96 xx	96 VDC
110 xx	110 VDC
xx	= to be defined

4. Weld no transfer

Weld no transfer standard

5. Relay cover type

–	Relay cover with lock pins
F	Relay cover for wire locking spring

6. Language on test report

–	French
1	English
2	Spanish





Mors Smitt France SAS

Tour Rosny 2, Avenue du Général de Gaulle,
F - 93118 Rosny-sous-Bois Cedex, FRANCE
T +33 (0)1 4812 1440, F +33 (0)1 4855 9001
E sales@msrelais.com

Mors Smitt Asia Ltd.

807, Billion Trade Centre, 31 Hung To Road
Kwun Tong, Kowloon, HONG KONG SAR
T +852 2343 5555, F +852 2343 6555
E info@morssmitt.hk

Mors Smitt B.V.

Vrieslantlaan 6, 3526 AA Utrecht,
NETHERLANDS
T +31 (0)30 288 1311, F +31 (0)30 289 8816
E sales@nieaf-smitt.nl

Mors Smitt Technologies Inc.

420 Sackett Point Road
North Haven, CT 06473, USA
T +1 (203) 287 8858, F +1 (888) 287 8852
E mstechnologies@msrelais.com

Mors Smitt UK Ltd.

Doulton Road, Cradley Heath
West Midlands, B64 5QB, UK
T +44 (0)1384 567 755, F +44 (0)1384 567 710
E info@morssmitt.co.uk