

## /// Instantaneous railway relay with 4 C/O contacts

Rugged plug-in relays for extreme reliability, within long endurance applications and harsh environments

### D-U200N

Instantaneous relay

Part of D-platform

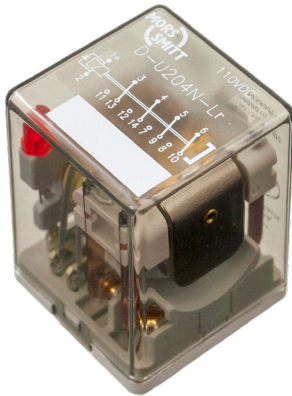

### Description

The D-U200N is the improved version of the famous D-U200 4-pole instantaneous relay. The dimensions, pinning and specifications are identical but it is much more reliable switching very low currents (1 mA @ 5 VDC). It is therefore the perfect relay to switch mixed loads.

The built-in magnetic arc blow-out ensures adequate DC breaking capacity resulting in long contact life and the now integrated contact separation prevents cross pollution of contacts better.

The operating temperature range is now -50 to + 85 Celsius. The IP40 dust ingress protection offers adequate protection allowing the relay to "breathe" ensuring long life whilst switching higher DC and inductive loads.

The back EMF coil protection diode comes standard with the D-U200N series. The information on the relay cover is extended with serial no. and data matrix code for ease of traceability.

The mechanical design and construction of the D-U200N relay is so rugged that it is fit to last in corrosive (salt, sulphate) environments, low and high temperatures, very dry and very high humidity, shock and vibrations and high altitudes.

Several operators use this relay since the 1970's and without a single incident. Indeed proven reliable and designed to survive train life!

The ultra-compact design, light weight, many options and the wide choice of sockets makes this the most flexible solution and preferred choice of many customers.

### Features

- Ultra compact, light weight
- 4 C/O contacts, self-cleaning
- Integrated back EMF suppression diode
- Magnetic arc blow-out ensuring long contact life
- Minimum switching current 1 mA
- Maximum continuous current 10 A
- Proven reliable
- Wide temperature range -50 °C...+85 °C
- Mechanical life > 50 million operations
- Electrical life e.g. > 10 million operations at 0.5 A, 24 VDC
- Data matrix with serial number for traceability
- Integrated snaplock, no external retaining clip needed
- Transparent cover for visual inspection
- Red or green LED optional
- Many options and sockets available

### Application

Relays keep on playing a vital role in reliable train operation. Key functions are galvanic isolation between control (computers/PLC's) and power circuits providing system isolation, contact multiplication and amplification.

Other unique features are predictable failure behavior (Fail Safe) making system safety validation a lot more simple than using computer based solutions like PLC's, long term availability = no obsolescence and easy maintenance by plug-in feature and transparent cover. Unlike more sensitive electronics relays are insensitive to EMI.

Using these features one can build a hardwired, fail safe control system which is cyber security safe and insensitive to electro magnetic disturbances and surges! Relays are ideal to use in trains for signal transfer/repeat, safety interlocking functions (brake - doors), load on-off switching and sub-system isolation.

### Connection diagram

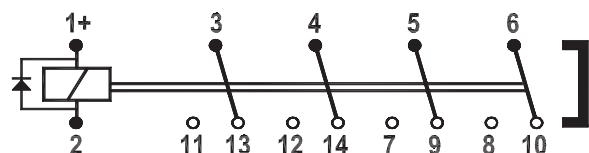

### Railway compliancy

EN 50155: 2017	EN 50121-3-2: 2016
IEC 60571: 2012	EN 45545-2: 2015
IEC 60077-1: 2017	NF F16-101/102
IEC 60947-5-1: 2016	IEC 60947-5-4: 2002
IEC 61373: 2010	



## Instantaneous relay D-U200N

### Options

- Weld-no-transfer contacts
- IP50 dust protection
- Red or green LED coil indicator
- Bipolar LED indicator
- 4 gold plated contacts
- 4 AgSnO<sub>2</sub> contacts, weld resistant for capacitive loads
- 1 gold plated signaling contact + 3 AgSnO<sub>2</sub> contacts
- Polarisation diode
- Double zener diode
- Push-to-test button
- AC/DC coil
- Double make / double break contacts
- No diode
- Keying (coding relay to correct socket)

Remark: Not all combinations possible



Red or green LED coil indicator



### Dimensions (mm)

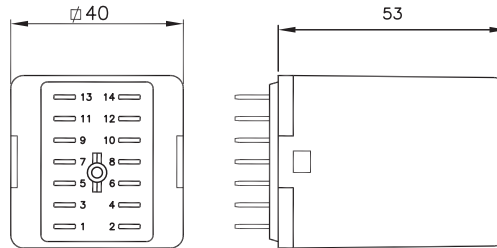

### Weight

~ 140 g

### Serializing

Each relay is marked with a unique serial number to which all important production information and test results are linked. The GTIN (Global Trade Item Number) and part number is printed on each relay in both text and data matrix code according the worldwide recognized GS1 standard, being able to scan each relay for logistical and traceability purposes.

### Sockets

		Mounting			
		Surface / Wall	35 mm rail	Panel / Flush	PCB
Terminal connection	Screw	V23	V23	-	-
	Screw - wide terminals	V22 BR	V23 BR	-	-
	Spring clamp	V29	V29	V33	-
	Faston	-	-	V31	-
	Crimp	-	-	V26	-
	Solder tag	-	-	V3	-
	PCB	-	-	-	V32

For more information see the respective datasheets

For more detailed technical specifications, drawings and ordering information, go to the product page on [www.morssmitt.com](http://www.morssmitt.com)

 **Over 10 million Mors Smitt relays in use in rail transport applications worldwide!**

**Mors Smitt Asia Ltd.**  
 26/F., Casey Aberdeen House  
 38 Heung Yip Road, Wong Chuk Hang  
 Hong Kong  
 Tel: +852 2343 555  
[sales.msa@wabtec.com](mailto:sales.msa@wabtec.com)

**Mors Smitt France SAS**  
 2 Rue de la Mandinière  
 72300 Sablé-sur-Sarthe, France  
 Tel: +33 (0) 243 92 82 00  
[sales.msf@wabtec.com](mailto:sales.msf@wabtec.com)

**Mors Smitt UK**  
 Graycar Business Park,  
 Burton on Trent, DE13 8EN, UK  
 Tel: +44 (0)1283 357 263  
[sales.msuk@wabtec.com](mailto:sales.msuk@wabtec.com)

**Wabtec Netherlands B.V.**  
 Darwinstraat 10,  
 6718 XR Ede, Netherlands  
 Tel: +31 (0)88 600 4500  
[sales.msbv@wabtec.com](mailto:sales.msbv@wabtec.com)

**Mors Smitt Technologies Ltd.**  
 1010 Johnson Drive,  
 Buffalo Grove, IL 60089-6918, USA  
 Tel: +1 847 777 6497  
[salesmst@wabtec.com](mailto:salesmst@wabtec.com)

**RMS Mors Smitt**  
 19 Southern Court,  
 Keysborough, VIC 3173, Australia  
 Tel: +61 (0)3 8544 1200  
[sales.rms@wabtec.com](mailto:sales.rms@wabtec.com)

(c) Copyright 2022

All rights reserved. Nothing from this edition may be multiplied, or made public in any form or manner, either electronically, mechanically, by photocopying, recording, or in any manner, without prior written consent from Mors Smitt. This also applies to accompanying drawings and diagrams. Due to a policy of continuous development Mors Smitt reserves the right to alter the equipment specification and description outlined in this datasheet without prior notice and no part of this publication shall be deemed to be part of any contract for the equipment unless specifically referred to as an inclusion within such contract. Mors Smitt does not warrant that any of the information contained herein is complete, accurate, free from potential errors, or fit for any particular purpose. Mors Smitt does not accept any responsibility arising from any party's use of the information in this document.

## Technical specifications

## Instantaneous relay D-U200N

### Coil characteristics

Inductance L/R at Unom (typical value):		
Energized		11 ms
Released		8 ms
Nominal power consumption		2.2 W @ Unom
Operating voltage range	EN 50155	0.7 - 1.25 Unom
DC power supply fluctuation range	EN 50155	0.6 - 1.4 Unom
Interruptions of power supply voltage	EN 50155	Class S2 (10 ms)

Type	Unom (VDC)	Umin (VDC)	Umax (VDC)	Udrop-out (VDC)	Rcoil * (Ω)	Icoil-nom (mA)
D-U201N	24	16.8	30	2.4	270	89
D-U202N	48	33.6	60	4.8	1046	46
D-U203N	72	50.4	90	7.2	2406	30
D-U204N	110	77	137.5	11	5330	21
D-U205N	96	67.2	120	9.6	4150	23
D-U206N	12	8.4	15	1.2	72	167
D-U207N	36	25.2	45	3.6	562	64
D-U208N	55	38.5	69	5.5	1300	42
D-U210N	120	84	150	12	6160	19
D-U213N	125	87.5	156.25	12.5	7634	16
D-U215N	220	154	275	22	21776	10
D-U220N	250	175	312.5	25	23850	10

Other types on request

\* The Rcoil is measured at room temperature and has a tolerance of  $\pm 10\%$ , with option L (LED) the value can differ

#### Remarks:

- Umin is the must-operate voltage at which the relay has picked up in all circumstances (worst-case situation), in practice the relay picks up at a lower voltage
- Udrop-out is the must-release voltage at which the relay has dropped-out in all circumstances (worst-case situation), in practice the relay drops out at a higher voltage
- Always select the nominal voltage as close as possible to the actual voltage in the application

### Operating range at various temperatures

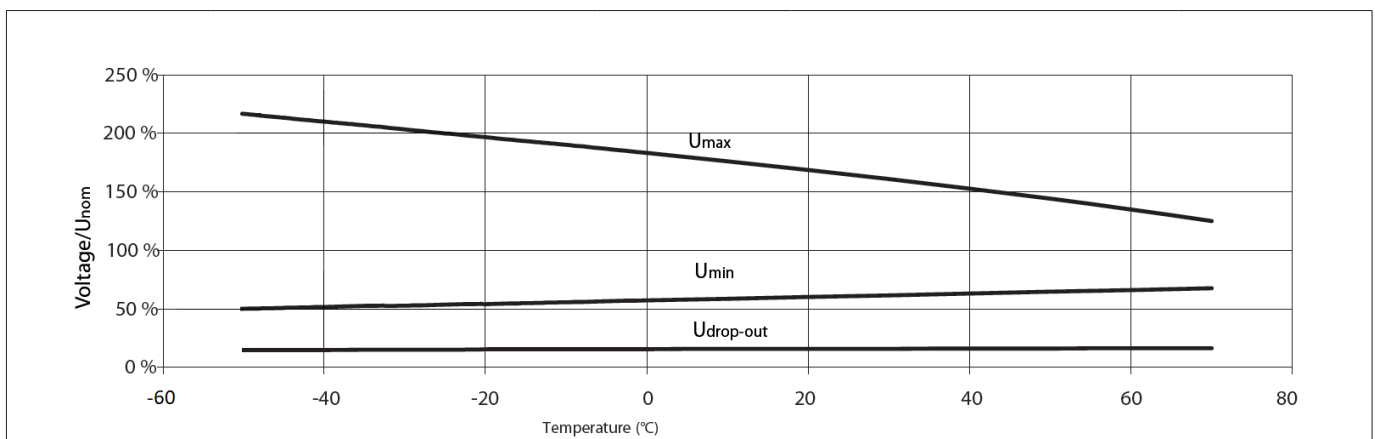

## Instantaneous relay D-U200N

### Contact characteristics

Contact configuration		4 C/O
Peak inrush current	NF F 62-002	200 A (withstand > 10 x 200 A @ 10 ms, 1 min) 80 A (withstand > 10 x 80 A @ 200 ms, 1 min) 40 A (withstand > 10 x 40 A @ 500 ms, 1 min) 30 A (withstand > 10 x 30 A @ 1000 ms, 1 min)
Continuous current		10 A
Maximum switching voltage		250 VDC, 440 VAC
Minimum switching voltage*		5 V
Minimum switching current*		1 mA
Maximum breaking capacity (> 50.000 operations)		110 VDC, 10 A (resistive load) 72 VDC, 5 A (L/R ≤ 40 ms) 110 VDC, 0.5 A (L/R ≤ 40 ms)
Contact resistance		15 mΩ (initial)
Material		Ag standard (optional AgSnO <sub>2</sub> , Au on Ag)
Contact gap		0.7 mm
Contact force		> 200 mN

\* Standard silver contacts tested in lab conditions. We strongly advice to always use gold plated contacts when switching very low currents, as long time reliable operation depends also on switching frequency and environmental conditions. Take recommendations for long time reliability on page 11 into account.

Operating times (ms) at nominal voltage (typical value)	Standard relay	With double zener diode (option Q)	Without diode (Option Z)
Operate time N/O contacts	18	17	19
Operate time N/C contacts	13	13	13
Release time N/O contacts	15	5	3
Release time N/C contacts	21	8	6
Bounce time N/O contacts	7	6	6
Bounce time N/C contacts	8	11	12

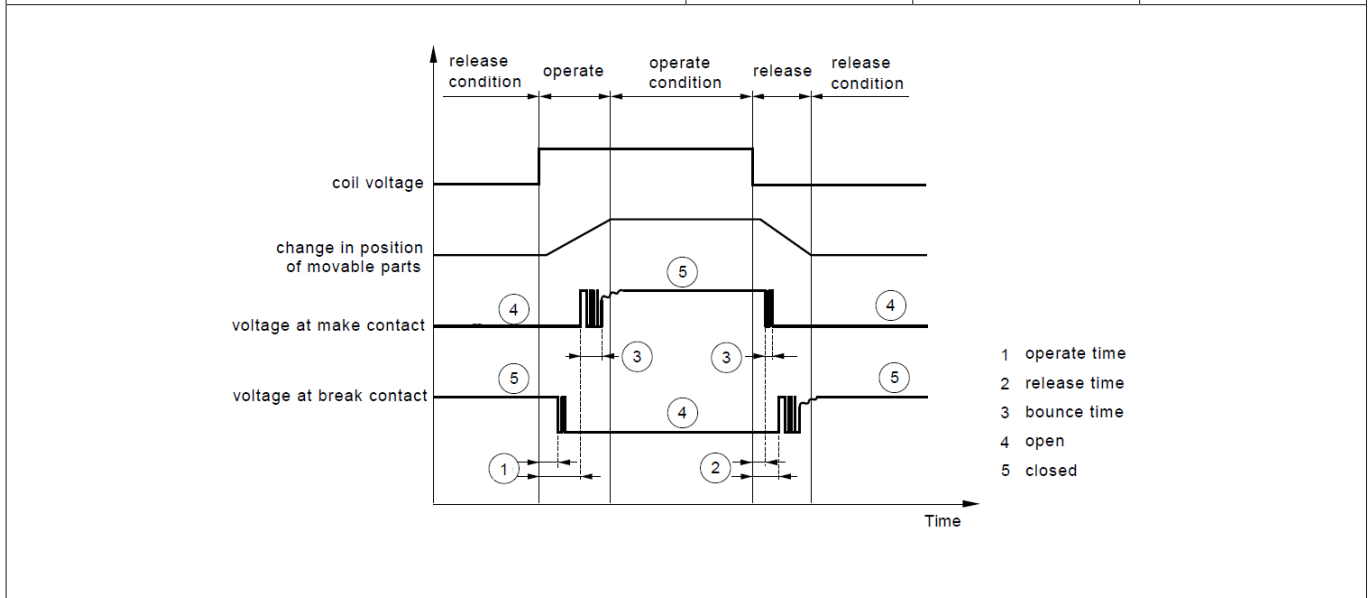

## Instantaneous relay D-U200N

### Contact reliability according IEC 60947-5-4

Contact switching load	Contact material	Failure rate $\lambda_c^*$	Mean number of operating cycles to contact failure $m_c^*$
1 mA , 5 VDC resistive	Gold (option E)	$5 \times 10^{-8}$	20.000.000
5 mA , 24 VDC resistive	Gold (option E)	$4 \times 10^{-8}$	25.000.000
10 mA , 50 VDC resistive	Silver (standard)	$2 \times 10^{-8}$	50.000.000

\*at confidence level 90%

Note: tested in factory environment at ambient temperature 20 °C. To underline the reliability of low current switching with the new D-U200N relay in parallel a 1 mA / 5 V test was done using standard silver contacts. The result was the same reliability. But since real train conditions are far different from Lab conditions we always recommend gold contacts for such low contact ratings.

### Electrical characteristics

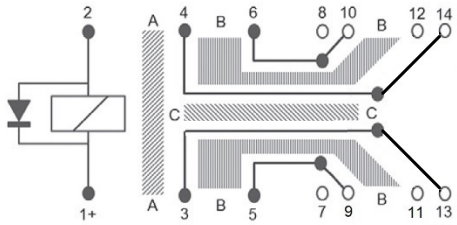
Dielectric strength	Pole-pole Cont-coil Open contacts	4 kV, 50 Hz, 1 min 2.5 kV, 50 Hz, 1 min 2.5 kV; 50 Hz; 1 min		
Clearance and creepage according IEC 60664-1 / EN 50124-2				
				
Section	Clearance	Creepage	Material group	Unom*
A	$\geq 2.2$ mm	$\geq 3.0$ mm	I (CTI600)	$\leq 220$ V
B	$\geq 3.0$ mm	$\geq 3.0$ mm	I (CTI600)	$\leq 300$ V
C	$\geq 6.1$ mm	$\geq 6.1$ mm	I (CTI600)	$\leq 696$ V
*For basic insulation, PD2 and OV3				
Pulse withstanding	IEC 60255-5	5 kV (1.2/50 $\mu$ s)		
Insulation resistance	EN 50155	> 20 M $\Omega$ (test voltage 500 VDC)		

### Environmental characteristics

Vibration	IEC 61373, Category I, Class B, Body mounted
Shock	IEC 61373, Category I, Class B, Body mounted
Operating temperature	-50 °C...+85 °C (+70 °C according EN 50155)
Operating temperature class	OT4 (tested @ -50 °C...+70 °C)
Humidity	98%
Maximum altitude	2000 meter. Higher altitudes are possible but have consequences mentioned in IEC 60664 (for example 5000 meter with bigger clearance distance)
Salt mist	IEC 60068-2-11, class ST4
Dry heat	IEC 60068-2-2 test Be
Damp heat	IEC 60068-2-30, Test method Db variant 1
Protection	IEC 60529, IP40 (relay on socket) (with option K: IP50)
Fire & smoke	NF F 16-101, NF F 16-102, EN 45545-2: HL3 for requirements R22, R23, R26
Insulation materials	Cover: polycarbonate Base: nylon
Natural cooling or forced ventilation constraints for the equipment	None: no extra measures necessary, relays can be mounted tightly together to save space
REACH: Registration, Evaluation, Authorisation and Restriction of Chemicals	European Regulation No 1907/2006

## Instantaneous relay D-U200N

### RAMS features

Life class	L4 (Useful life 20 years, take electrical life cycle curves into account)
Repairability	Non-repairable
Maintenance instructions	See inspection/maintenance on page 12
Reliability / lifetime Mechanical lifetime  Low energy electrical lifetime High energy electrical lifetime	> 50 million operations, maximum switching frequency 1 Hz (1 million operations at -50 °C) 5 million operations, maximum switching frequency 1 Hz See life cycle curves on page 8
Storage precautions	Storage temperature: -50 °C...+85 °C Store in original packaging

### Product labeling

Part number identification	Part number mentioned on top side relay
Serial number identification	Serial number mentioned on top side relay Serial number = Lot number + year + week + reference number
Data matrix code	According GS1 standard, placed on top side relay 01 Global Trade Item Number 240 Part number 21 Serial number Example: 011234567890123240123456789211234562209001
Revision index identification	Linked to serial number
Terminals	Identification on bottom plate relay Relay to be used with Mors Smitt relay sockets which have clear terminal identification on each socket

### Railway compliancy

EN 50155: 2017	Railway applications - Rolling stock - Electronic equipment
IEC 60571: 2012	Railway applications - Electronic equipment used on rolling stock
IEC 60077-1: 2017	Railway applications - Electric equipment for rolling stock
IEC 60947-5-1: 2016 / IEC 60947-5-4: 2012	Low-voltage switchgear and controlgear
IEC 61373: 2010	Railway applications - Rolling stock equipment - Shock and vibration tests
EN 50121-3-2: 2016	Railway applications - Electromagnetic compatibility
NF F16-101/102	Railway rolling stock - Fire behavior
EN 45545-2: 2015	Railway applications - Fire protection on railway vehicles Part 2: Requirements for fire behavior of materials and components



## Instantaneous relay D-U200N

### Options

Code	Description	Remark	Cannot be combined with:
------	-------------	--------	--------------------------

#### Standard options:

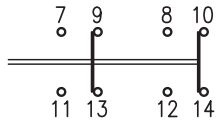
E*	Au; Gold plated contacts (10 µm)		E1M3, M
K	Extra dust protection	IP50 Cat 2 for the relays mounted in a Mors Smitt socket. Application PD1/PD2 and contact load > 0.5 A.	T
Lg**	Green LED integrated in coil	For 24/72/110 VDC. (Other voltages on request)	X, X2
Lr**	Red LED integrated in coil		X, X2
Q	Double zener diode over coil	Unom ≤ 120V. Maximum allowed peak voltage 180 V, higher voltage will damage the diode. Replaces back EMF diode.	X2, Z
W	Weld-no-transfer contacts	See datasheet D-U200N-W	T
Y	Double make/double break contacts, contact gap 1.4 mm	2 C/O DM/DB  	E1M3
Z	No diode	Polarity independent	P, Q, X2
Keying	Coil coding relay and socket		

#### Special options:

E1M3	1 Gold plated signaling contact and 3 AgSnO <sub>2</sub> contacts	See remarks option E and option M. On request, contact Mors Smitt for more information	E, M, Y
M	AgSnO <sub>2</sub> ; "non-weldable" contacts, used for capacitive loads e.g. LED lighting	Icontact > 100 mA	E, E1M3
P	Polarisation diode		X, X2, Z
T	Push to test button		K, W
X	Bipolar red LED	Only in combination with Q or Z	Lr/Lg, P, X2
X2	AC/DC rectifier bridge	Replaces back EMF diode.	Lr/Lg, P, Q, X, Z

#### \* Gold plated contacts characteristics

Material	Ag, 10 µm gold plated
Maximum switching voltage	60 V (higher voltages may be possible, contact Mors Smitt for more information)
Maximum switching current	400 mA (at higher rate gold will evaporate, then the standard silver contact rating of minimum 10 mA and 12 V is valid)
Minimum switching voltage	5 V
Minimum switching current	1 mA

\*\* LED in series with coil: besides ON/OFF information also indicator when relay coil wire is broken, then LED always OFF. When LED is broken the relay still works correct.

Remark: For application support or technical product support, contact your local Mors Smitt sales office (see contact details on last page).



## Instantaneous relay D-U200N

### Electrical life expectancy

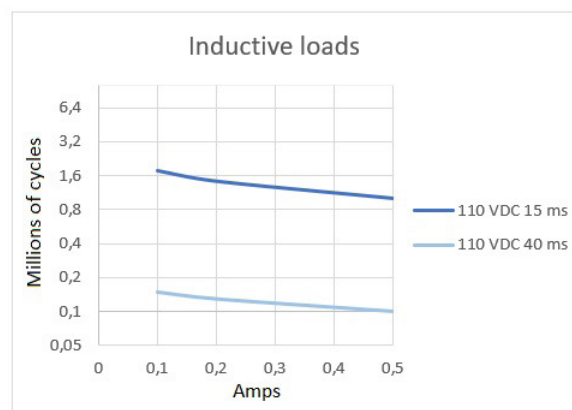
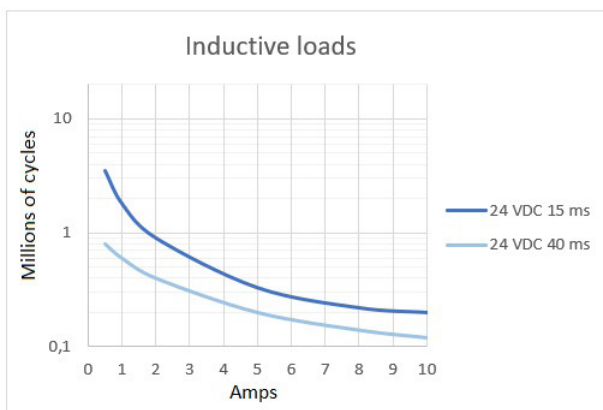
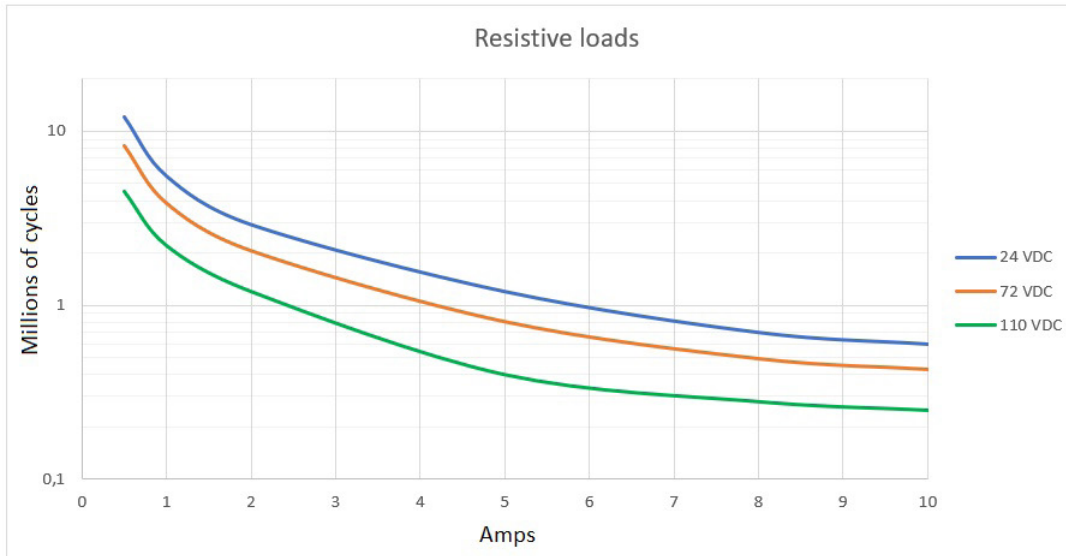

By connecting 2 contacts in series the DC current breaking capacity is increased by 50 %. Electrical lifetime is tested under laboratory conditions with switching frequency 0.33 Hz.

Note: The actual electrical lifetime in the application is affected by the switching frequency, type of contact (N/O or N/C), environmental conditions, etc.

For highly inductive loads Mors Smitt A400/B400 relays with standard double make double break contacts are the optimal solution.

### Self-cleaning contacts

Each contact attracts organic molecules. When the surface is loaded with a voltage, like a relay contact, the attracting force is even higher. Therefore on each contact surface there is organic "pollution".

Mors Smitt relays are designed to clean itself during switching of the contacts:

1. Mechanical wiping action: the "pollution" is swept aside.  
The movement of opposing contacts when they make contact: this wiping action cleans the surface of both contacts. Mors Smitt relays are designed for optimal wiping action: enough to clean the surface and not too much to prevent contact wear.
2. Electrical cleaning: the "pollution" is burnt away.  
A current at sufficient level will evaporate organic "pollution". When switching loads (typically of a current >100 mA), the "pollution" is totally burnt away and a clean contact surface is available.

The result is a good contact between two opposing contacts without interference due to polluted contacts.



## Instantaneous relay D-U200N

### Mounting possibilities/sockets



#### Surface/wall mounting

338000302	V22BR	Screw socket, wall mount, front connection (9 mm terminals)
338000580	V23	Screw socket, wall mount, front connection (7.5 mm terminals)
338000610	V29	Spring clamp socket, wall mount, front dual connection (2.5 mm <sup>2</sup> )

#### Rail mounting

338000580	V23	Screw socket, rail mount, front connection (7.5 mm terminals)
338000402	V23BR	Screw socket, rail mount, front connection (9 mm terminals)
338000610	V29	Spring clamp socket, rail mount, front dual connection (2.5 mm <sup>2</sup> )

#### Panel/flush mounting

338100100	V3	Solder tag socket, panel mount, rear connection
328400100	V26	Crimp contact socket, panel mount, rear connection, A260 crimp contact
338000560	V31	Faston connection socket, rear dual connection (4.8 x 0.8 mm)
338000670	V33	Push-in terminal socket, panel mount, rear dual connection (3.3 mm <sup>2</sup> )

#### PCB mounting

338000561	V32	PCB soldering socket
-----------	-----	----------------------

No external retaining clip needed as the 'snap-lock' will hold the relay into the socket under all circumstances and mounting directions (according shock & vibration requirements IEC 61373, Category I, Class B, Body mounted). If regulations require external retaining clips, these are available as well.

For more details see datasheets of the sockets on [www.morssmitt.com](http://www.morssmitt.com)

## Instantaneous relay D-U200N

### Mechanical keying relay and socket (optional)

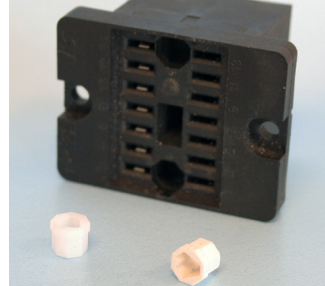

**Function:**

- To prevent wrong installation
- To prevent damage to equipment
- To prevent unsafe situations

Using keyed relays and sockets prevents a relay is inserted in a wrong socket. For example it prevents that a 24 VDC relay is put in a 110 VDC circuit. Positive discrimination is possible per different function, coil voltage, timing, monitoring, safety and non-safety.

The D relay socket keying option gives  $8 \times 8 = 64$  possibilities. Upon ordering the customer simply indicates the need for the optional keying. Mors Smitt will assign a code to the relay and fix the pins into the relay. The sockets are supplied with loose key receptacles. Inserting the keys into the socket is very simple and self explaining.

Remark: Sockets and relay shown are examples.

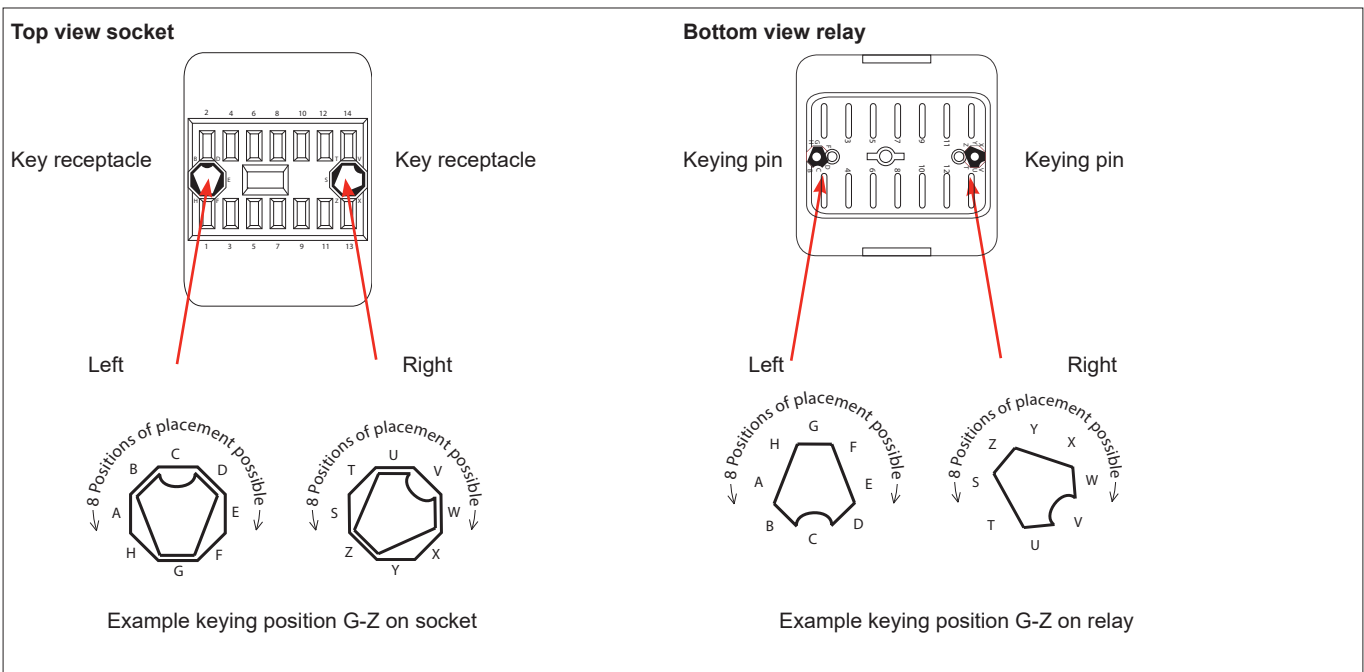

## Instantaneous relay D-U200N

### Important for relay selection and operation

Make sure the relay is suitable for the application. For critical applications (for example: green loop applications) relays should be checked on correct working during periodic inspection.

#### Contact switching current

Each relay has a range of switching currents in which it performs optimally: the sweet spot. As switching currents are decreasing in field applications, the D-U200N relay has an improved sweet spot compared to its predecessors.

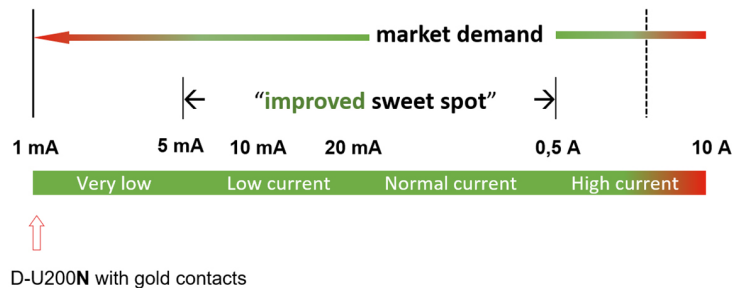

#### Recommendations for long time contact reliability

For relays to enable failure free performance over a very long operational time, it is important to create the right circumstances. In any relay, contact usage and atmospheric conditions influence the contact surface. To counter this effect it is common practice to use a safety factor of  $> 2$  to ensure long time contact reliability.

Therefore for long time contact reliability we recommend:

- Silver contacts: a minimum contact current of 20 mA per contact
- Gold contacts: a minimum contact current of 10 mA per contact
- Double Make Double Break contacts: a minimum contact current of 40 mA per contact
- When low currents are switched and not frequently, e.g. 10 mA once a day, it is advised (next to gold plated contacts) to put similar contacts within the same relay in parallel
- With higher load switching, e.g. 110 VDC and  $> 1$  A, put relay contacts in series
- Rule of thumb: any relay works best with switching currents  $> 20$  mA in DC environment when frequently switched. When not switched frequently a higher switching current like 50 mA is better for a long reliable operational time
- When switching capacitive loads (e.g. LED lighting) always use silver tin oxide contacts (minimal contact current 100 mA)
- Check relays regularly, for example with the Mors Smitt Portable Relay Tester and visually through the transparent cover

### Instructions for use

#### Installation

Before installation or working on the relay: disconnect the power supply first (no hot swapping)! Install socket and connect wiring according to the terminal identification. Plug relay into the socket ensuring there is no gap between the bottom of relay and the socket. Reverse installation into the socket is not possible due to the mechanical blocking snap-lock feature. Check to ensure that the coil connection polarity is not reversed. Relays can be mounted tightly together to save space. When rail mounting is used, always mount the socket in the direction of the UP arrow, to have proper fixation of the socket on the rail.

#### Warning!

- Never use silicon in the proximity of the relays
- Do not use the relay in the presence of flammable gas as the arc generated from switching could cause ignition
- To remove relays from the socket, employ up and down lever movements. Sideway movement may cause damage to the coil wires

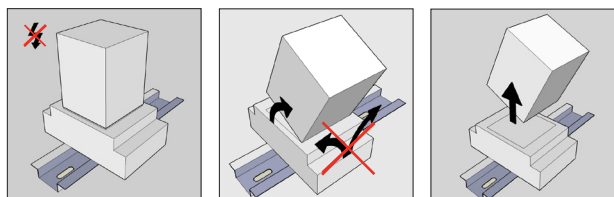

- Relays should never be swapped to other circuit positions when taken out of its socket for inspection or fault finding, always place it back into the original position to prevent contact resistance problems. Contact resistance problems can be created when swapping relays between different circuit loads due to the contact wear/condition having changed during its operational life.

## Instantaneous relay D-U200N

### Operation

After installation always apply the rated voltage to the coil to check correct operation. Long term storage may corrode the silver on the relay pins. When plugging the relay into the socket, the female bifurcated or trifurcated receivers will automatically cut through the corrosion on the pins and guarantee a reliable connection.

Before actual use of relays, it is advised to switch the load several times with the contacts. The contacts will both be electrically and mechanically cleaned due to the positive wiping action. Sometimes a contact can build up increased contact resistance ( $\leq 15 \text{ m}\Omega$  when new). When using silver contacts one can clean the contact by switching a contact load a few times using  $>24 \text{ VDC}$  &  $\sim 2\text{A}$ . Increased contact resistance is not always problematic, as it depends on circuit conditions. In general a contact resistance of  $1 \Omega$  is no problem, consult Mors Smitt for more information.

Condensation in the relay is possible when the coil is energised (warm) and the outside, environmental temperature is cold. This is a normal phenomenon and will not affect the function of the relay. Materials in the relay have no hygroscopic properties.

### Inspection / maintenance

Correct operation of the relay can easily be checked as the transparent cover provides good visibility of the moving contacts. If the relay does not seem to operate correctly, check for presence of the appropriate coil voltage and polarity using a suitable multimeter. If a LED is fitted, it indicates voltage presence to the coil. If coil voltage is present, but the relay does not operate, a short circuit of the suppression diode is possible (likely caused by reversed coil connection).

Relays can easily be tested with the Mors Smitt Relay Tester. More information on: [www.morssmitt.com](http://www.morssmitt.com).

If the relay doesn't work after inspection, replace the relay unit with a similar model. Do not attempt to open the relay cover or try to repair. Contacts are calibrated and in balance, touching can affect proper operation. Also resoldering may affect correct operation. Since 2009 relays have tamper proof seals fitted and once broken, warranty is void.

Most relay defects are caused by installation faults such as overvoltage, spikes/transients, high/short current far exceeding the relay specifications. When returning the relays for investigation, please provide all information on the RMA form. Send defective relays back to the manufacturer for repair or replacement. Normal wear and tear or external causes are excluded from warranty.

RMA procedure see [www.morssmitt.com](http://www.morssmitt.com)

## Instantaneous relay D-U200N

### Ordering scheme

D-U2	N -	Code		
Coil voltages	01		24 VDC	
	02		48 VDC	
	03		72 VDC	
	04		110 VDC	
	05		96 VDC	
	06		12 VDC	
	07		36 VDC	
	08		55 VDC	
	10		120 VDC	
	13		125 VDC	
	15		220 VDC	
	20		250 VDC	
	Cannot be combined with:			
Options (add as many options as needed, always in alphabetical order)	E		Gold plated contacts	E1M3, M
	K		Extra dust protection, IP50	T
	Lg		Green LED coil indicator	X, X2
	Lr		Red LED coil indicator	X, X2
	Q		Double zener diode	X2, Z
	Wxxx		Weld-no-transfer contacts, (see separate datasheet D-U200N-W)	T
	Y		Double make/ double break	E1M3
Special options (minimum order quantity: 20)	Z		No diode	P, Q, X2
	E1M3		1 Gold, 3 AgSnO <sub>2</sub> contacts	E, M, Y
	M		AgSnO <sub>2</sub> contacts, highly resistant to welding	E, E1M3
	P		Polarisation diode	X, X2, Z
	T		Push-to-test-button	K, W
	X		Bipolar red LED	Lr/Lg, P, X2
Keying code (optional, leave blank if not required)  Remark: keying codes are available for all possible coil voltages.	<b>Standard, silver contacts</b>			
	AS		24 VDC	
	AY		36 VDC	
	AT		48 VDC	
	AU		72 VDC	
	AV		110 VDC	
	<b>Option E, gold contacts</b>			
	DT		24 VDC	
	FV		36 VDC	
	HU		48 VDC	
	AZ		72 VDC	
	HV		110 VDC	
	<b>Option M, silver tin oxide contacts</b>			
	GT		24 VDC	
	HT		36 VDC	
	GU		48 VDC	
	GV		72 VDC	
	GW		110 VDC	

Examples:

**D-U204N-Lg code AV**

Description: D-U200N relay, Unom 110 VDC, green LED coil indicator, keying code AV

**D-U201N-EKLg**

Description: D-U200N relay, Unom 24 VDC, gold plated contacts, extra dust protection, green LED coil indicator

**D-U203N-E1M3KLrQ**

Description: D-U200N relay, Unom 72 VDC, 1 gold and 3 AgSnO<sub>2</sub> contacts, extra dust protection, red LED coil indicator, double zener diode



**Instantaneous relay**  
**D-U200N**

---

 **Over 10 million Mors Smitt relays in use in rail transport applications worldwide!**

**Mors Smitt Asia Ltd.**  
26/F., Casey Aberdeen House  
38 Heung Yip Road, Wong Chuk Hang  
Hong Kong  
Tel: +852 2343 555  
sales.msa@wabtec.com

**Mors Smitt France SAS**  
2 Rue de la Mandinière  
72300 Sablé-sur-Sarthe, France  
Tel: +33 (0) 243 92 82 00  
sales.msf@wabtec.com

**Mors Smitt UK**  
Graycar Business Park,  
Burton on Trent, DE13 8EN, UK  
Tel: +44 (0)1283 357 263  
sales.msuk@wabtec.com

**Wabtec Netherlands B.V.**  
Darwinstraat 10,  
6718 XR Ede, Netherlands  
Tel: +31 (0)88 600 4500  
sales.msbv@wabtec.com

**Mors Smitt Technologies Ltd.**  
1010 Johnson Drive,  
Buffalo Grove, IL 60089-6918, USA  
Tel: +1 847 777 6497  
salesmst@wabtec.com

**RMS Mors Smitt**  
19 Southern Court,  
Keysborough, VIC 3173, Australia  
Tel: +61 (0)3 8544 1200  
sales.rms@wabtec.com

(c) Copyright 2022

All rights reserved. Nothing from this edition may be multiplied, or made public in any form or manner, either electronically, mechanically, by photocopying, recording, or in any manner, without prior written consent from Mors Smitt. This also applies to accompanying drawings and diagrams. Due to a policy of continuous development Mors Smitt reserves the right to alter the equipment specification and description outlined in this datasheet without prior notice and no part of this publication shall be deemed to be part of any contract for the equipment unless specifically referred to as an inclusion within such contract. Mors Smitt does not warrant that any of the information contained herein is complete, accurate, free from potential errors, or fit for any particular purpose. Mors Smitt does not accept any responsibility arising from any party's use of the information in this document.