

/// Plug-in railway relay with 1 contact, current monitoring

Rugged plug-in relays for extreme reliability, within long endurance applications and harsh environments

CU/CP-U900-I

Instantaneous relay

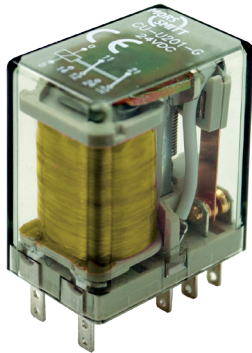

(picture CU-U200-G is shown)

Description

Miniature current monitoring railway relay with one change-over contact. Suitable for AC or DC currents. Very sensitive and high insulation between coil and contact. Relay for plug-in mounting (CU version) or PCB mounting (CP version).

The construction of the relay and choice of materials makes the CU/CP-U900-I relay suitable to withstand corrosive atmospheres, low and high temperatures, shock & vibrating and dry to very humid environments.

With a very compact design and a wide range of sockets, the CU/CP-U900-I relay is an easy and flexible solution to use.

Application

These relays are designed for rolling stock applications where available space is limited. The CU/CP-U900-I is used in applications for current monitoring or where switching is activated by a fixed current level.

Features

- Miniature current monitoring relay
- Instantaneous, 1 C/O contact
- AC or DC coil
- Very sensitive
- High insulation between coil and contact
- Flat, square and tin plated relay pins for excellent socket connection / PCB mounting pins
- Wide range sockets
- Transparent cover
- High insulation because of flash barrier
- Optional positive mechanical keying relay to socket

Connection diagram

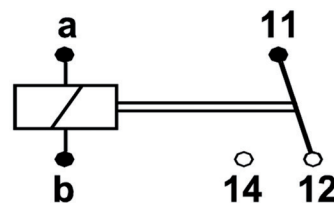

Timing diagram

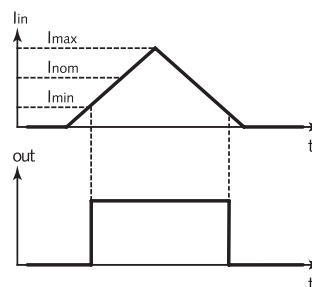

Railway compliancy

EN 50155	EN 50121-3-2
IEC 60571	EN 45545-2
IEC 60077-1	NF F16-101/102
IEC 60947-5-1	
IEC 61373	

Instantaneous relay CU/CP-U900-I

Options

- Non-sinusoidal currents (AC only)
- Gold plated contacts

Dimensions (mm)

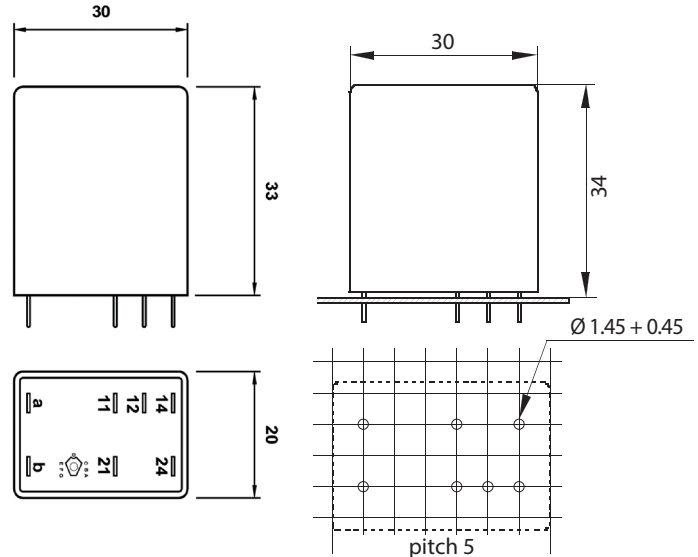

CU version

CP version

Hole size: $\text{Ø } 1.45 \dots 1.90 \text{ mm}$, $\text{Ø } 1.5 \text{ mm}$ recommended
 Spot size: minimum $\text{Ø } 2.4 \text{ mm}$, $\text{Ø } 3.2 \text{ mm}$ recommended

Sockets

Terminal connection	Mounting	
	Wall / rail mount	PCB
Screw	V16	
Spring clamp	V17	
PCB		V18

For more detailed technical specifications, drawings and ordering information, go to the product page on www.morssmitt.com

 **Over 10 million Mors Smitt relays in use in rail transport applications worldwide!**

Mors Smitt Asia Ltd.
 Unit B & C, 25/F., Casey Aberdeen House,
 38 Heung Yip Road, Wong Chuk Hang,
 Hong Kong
 Tel: +852 2343 555
sales.msa@wabtec.com

Mors Smitt France SAS
 2 Rue de la Mandinière
 72300 Sablé-sur-Sarthe, France
 Tel: +33 (0) 243 92 82 00
sales.msf@wabtec.com

Mors Smitt UK Ltd.
 Graycar Business Park,
 Burton on Trent, DE13 8EN, UK
 Tel: +44 (0)1283 357 263
sales.msuk@wabtec.com

Wabtec Netherlands
 Darwinstraat 10,
 6718 XR Ede, Netherlands
 Tel: +31 (0)88 600 4500
sales.msbv@wabtec.com

Mors Smitt Technologies Ltd.
 1010 Johnson Drive,
 Buffalo Grove, IL 60089-6918, USA
 Tel: +1 847 777 6497
salesmst@wabtec.com

RMS Mors Smitt
 6 Anzed Court,
 Mulgrave, VIC 3170, Australia
 Tel: +61 (0)3 8544 1200
sales.rms@wabtec.com

(c) Copyright 2020

All rights reserved. Nothing from this edition may be multiplied, or made public in any form or manner, either electronically, mechanically, by photocopying, recording, or in any manner, without prior written consent from Mors Smitt. This also applies to accompanying drawings and diagrams. Due to a policy of continuous development Mors Smitt reserves the right to alter the equipment specification and description outlined in this datasheet without prior notice and no part of this publication shall be deemed to be part of any contract for the equipment unless specifically referred to as an inclusion within such contract. Mors Smitt does not warrant that any of the information contained herein is complete, accurate, free from potential errors, or fit for any particular purpose. Mors Smitt does not accept any responsibility arising from any party's use of the information in this document.

Technical specifications

Instantaneous relay CU/CP-U900-I

Coil characteristics

Operating times at nominal voltage (typical)	
Pull-in time	≤ 15 ms
Release time	≤ 3 ms
Bounce time N/O contacts	≤ 1 ms
Bounce time N/C contacts	≤ 1 ms
Release current	5 %... 20 % I_{nom}
Operating voltage range	40 %...120 % I_{nom} AC, 40 %...150 % I_{nom} DC

DC versions

Type	I_{nom} (ADC)	I_{min} (ADC)	I_{max} (ADC)	$U_{drop-out}$ (VDC) at I_{nom}
U904-I	0.12	0.048	0.18	3.5
U914-I	0.18	0.072	0.27	2.1
U913-I	0.25	0.1	0.37	1.4
U903-I	0.39	0.156	0.59	0.93
U912-I	0.6	0.24	0.9	0.61
U915-I	0.072	0.029	0.108	5.2
U911-I	1.0	0.4	1.5	0.39
U910-I	1.5	0.6	2.25	0.26
U909-I	2.4	0.96	3.6	0.21
U908-I	4.4	1.76	6.6	0.15

Other types on request

Nominal consumption

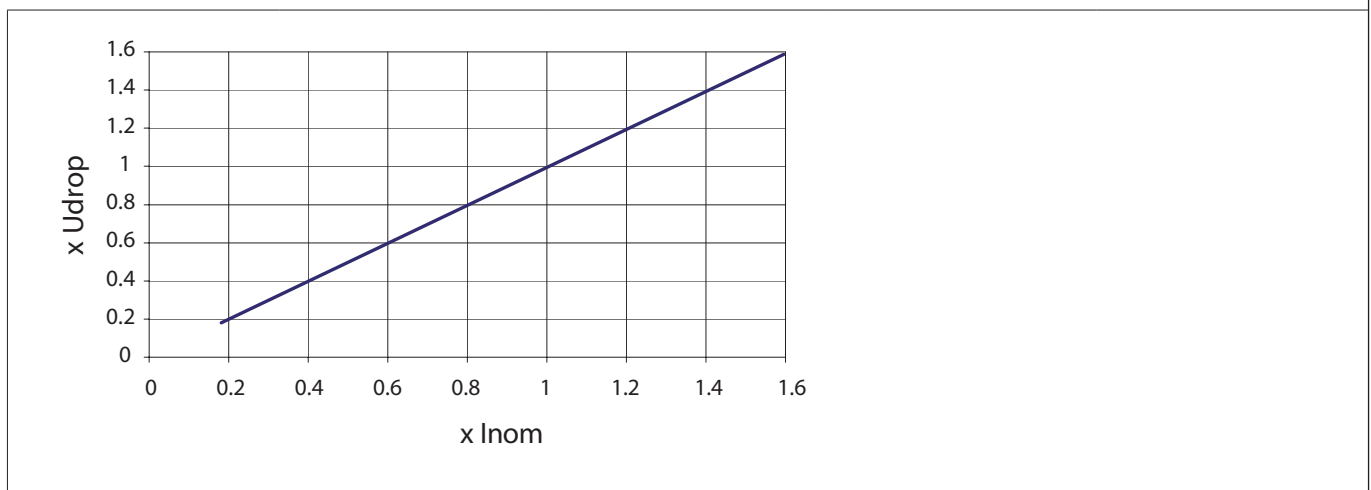

Instantaneous relay CU/CP-U900-I

AC versions

Type	I_{nom} (AAC)	I_{min} (AAC)	I_{max} (AAC)	Udrop-out (VAC) at I_{nom} 50 Hz	Udrop-out (VAC) at I_{nom} 60 Hz
U955-I	0.12	0.048	0.144	11	13
U962-I	0.18	0.072	0.216	6.9	8.1
U954-I	0.27	0.11	0.324	5.5	6.4
U961-I	0.38	0.152	0.456	3.6	4.2
U960-I	0.6	0.24	0.72	2.4	2.7
U963-I	0.072	0.029	0.086	18	21
U952-I	1.0	0.4	1.2	1.4	1.6
U959-I	1.5	0.6	1.8	0.9	1.1
U958-I	2.4	0.96	2.88	0.6	0.7

Other types on request

Nominal consumption

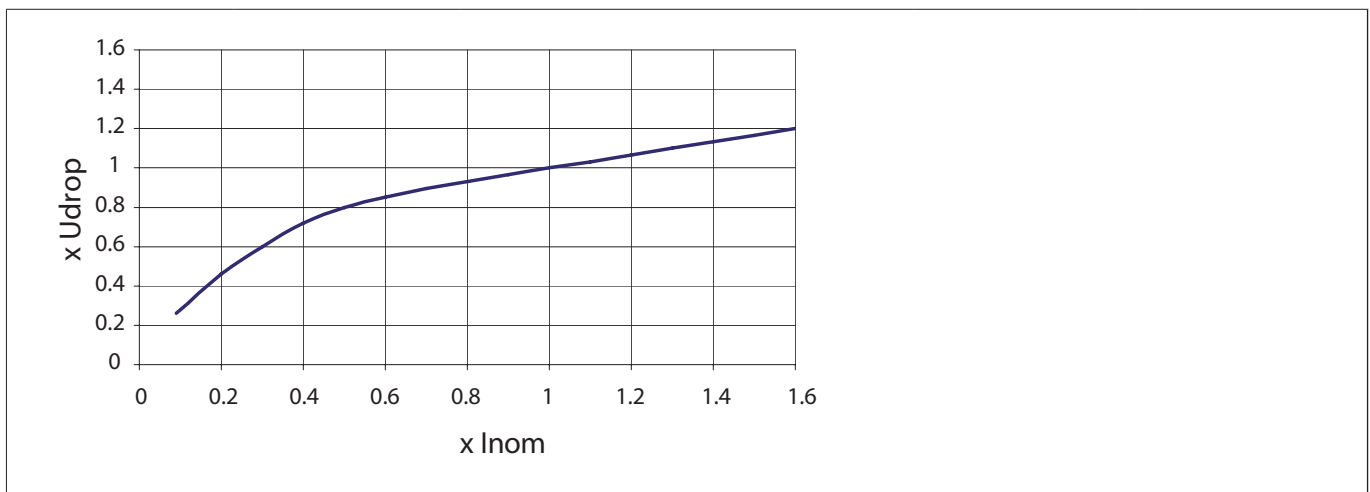

Contact characteristics

Amount and type of contacts	1 C/O
Maximum make current	15 A
Maximum continuous current	6 A
Maximum switching voltage	300 VDC (then max. current = 300 mA) 250 VAC (then max. current = 2.6 A)
Minimum switching voltage	12 V
Minimum switching current	10 mA
Maximum contact resistance	15 m Ω (initial)
Maximum switching capacity	See graph page 6
Material	Ag
Contact gap	0.3 mm
Contact force	> 20 cN

Instantaneous relay CU/CP-U900-I

Electrical characteristics

Dielectric strength	Cont-coil	3.5 kV, 50 Hz
	Open contacts	1.0 kV; 50 Hz; 1 min
Pulse withstanding	IEC 60255-5	5 kV (1.2/50 μ s)

Mechanical characteristics

Mechanical life	30 x 10 ⁶ operations
Maximum switching frequency	Mechanical: 3600 ops/h Electrical: 1200 ops/h
Weight	40 g

Environmental characteristics

Environmental	EN 50125-1 and IEC 60077-1
Vibration	IEC 61373, Category I, Class B, Body mounted
Shock	IEC 61373, Category I, Class B, Body mounted
Operating temperature	-40 °C...+85 °C (option E -25 °C...+85 °C)
Humidity	95% (condensation is permitted temporarily)
Maximum altitude	2000 meter. Higher altitudes are possible but have consequences mentioned in IEC 60664 (for example 5000 meter with bigger clearance distance)
Salt mist	IEC 60068-2-11, class ST4
Damp heat	IEC 60068-2-30, Test method Db variant 1
Protection	IEC 60529, IP40 (relay on socket)
Fire & smoke	NF F 16-101, NF F 16-102, EN 45545-2: HL3 for requirements R22, R23, R26
Insulation materials	Cover: polycarbonate Base: polyester

Railway compliancy

EN 50155	Railway applications - Rolling stock - Electronic equipment
IEC 60571	Railway applications - Electronic equipment used on rolling stock
IEC 60077	Railway applications - Electric equipment for rolling stock
IEC 60947	Low-voltage switchgear and controlgear
IEC 61373	Railway applications - Rolling stock equipment - Shock and vibration tests
EN 50121	Railway applications - Electromagnetic compatibility
NF F16-101/102	Railway rolling stock - Fire behavior
EN 45545-2	Railway applications - Fire protection on railway vehicles Part 2: Requirements for fire behavior of materials and components
IEC 60529	European standard describes the protection class (IP-code)

Instantaneous relay CU/CP-U900-I

Options

Code	Description	Remark	Cannot be combined with:
Standard options:			
A	Non-sinusoidal currents (AC only)		
E*	Au; Gold plated contacts (10 µm)		

* Gold plated contacts characteristics	
Material	Ag, 10 µm gold plated
Maximum switching voltage	60 V (higher voltages may be possible, contact Mors Smitt for more information)
Maximum switching current	400 mA (at higher rate gold will evaporate, then the standard silver contact rating of minimum 10 mA and 12 V is valid)
Minimum switching voltage	5 V
Minimum switching current	1 mA

Remark: For application support or technical product support, contact your local Mors Smitt sales office (see contact details on last page).

Instantaneous relay CU/CP-U900-I

Switching capacity and contact life

Maximum switching capacity

Maximum switching capacity

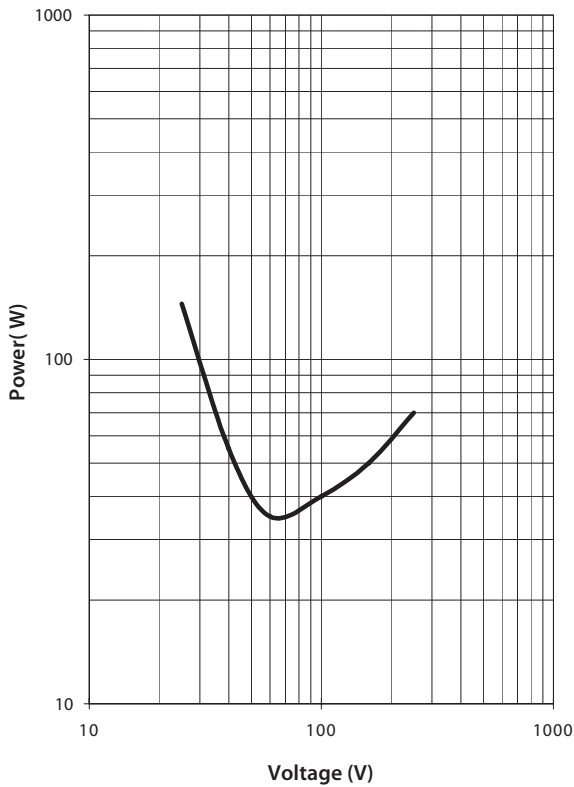

Electrical life expectancy

Electrical life expectancy

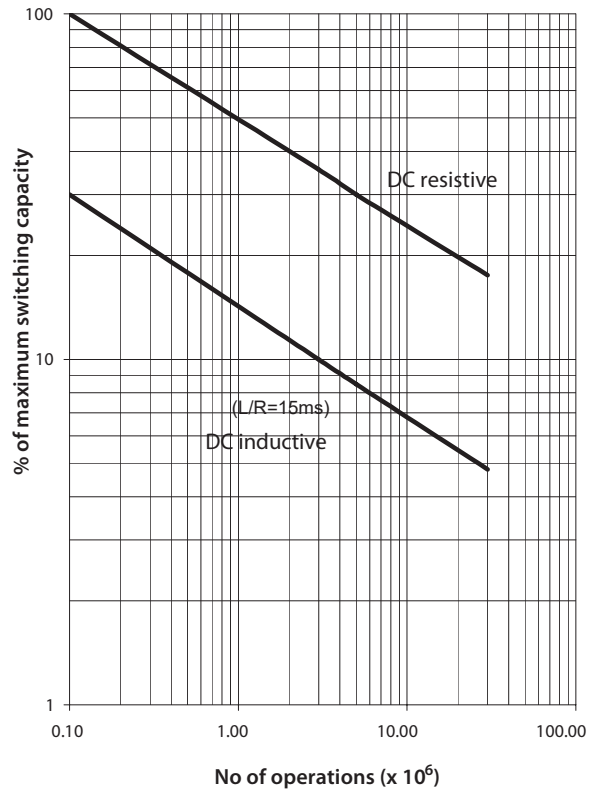

- Step 1: Determine switching voltage out of the application.
- Step 2: Select the maximum switching capacity (in Watt) at this voltage in graph 'Maximum switching capacity'.
- Step 3: Calculate the actual switched load (in Watt) out of the application.
- Step 4: Calculate the % of maximum switching capacity: $\frac{\text{Actual load}}{\text{Max switching capacity}}$
- Step 5: Pick the life at this load out of the graph 'Electrical life expectancy'.

Instantaneous relay CU/CP-U900-I

Mounting possibilities/sockets



The CU/CP relays can be mounted in any position except with the connecting pins pointing upwards.

Relays and sockets are all tested to the IEC 61373. For rail mounting it is recommended to mount the socket with the spring side down (that means contacts 14-12-22-24 upwards).

338001500	V16	Relay socket, screw terminal, wall/rail mount, front connection
338001400	V17	Relay socket, spring terminal, wall/rail mount, front connection
338000620	V18	Relay socket for soldering on PCB

Optional: Diode / double zener diode in the socket.

For more details see datasheets of the sockets on www.morssmitt.com

Instantaneous relay CU/CP-U900-I

Mechanical keying relay and socket (optional)

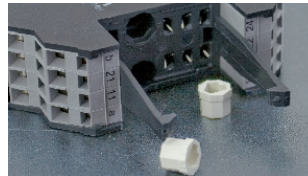
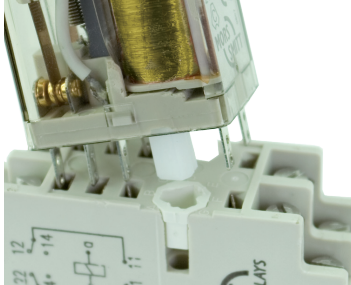

Function:

- To prevent wrong installation
- To prevent damage to equipment
- To prevent unsafe situations

Using keyed relays and sockets prevents a relay is inserted in a wrong socket. For example it prevents that a 24 VDC relay is put in a 110 VDC circuit. Positive discrimination is possible per different function, coil voltage, timing, monitoring, safety and non-safety.

The CU-relay socket keying option gives 8 possibilities. Upon ordering the customer simply indicates the need for the optional keying. Mors Smitt will assign a code to the relay and fix the pins into the relay. Loose key receptacles can be ordered as well when sockets without pre-installed keys need keying. Inserting the keys into the socket is very simple and self explaining.

Remark: Sockets and relay shown are examples.

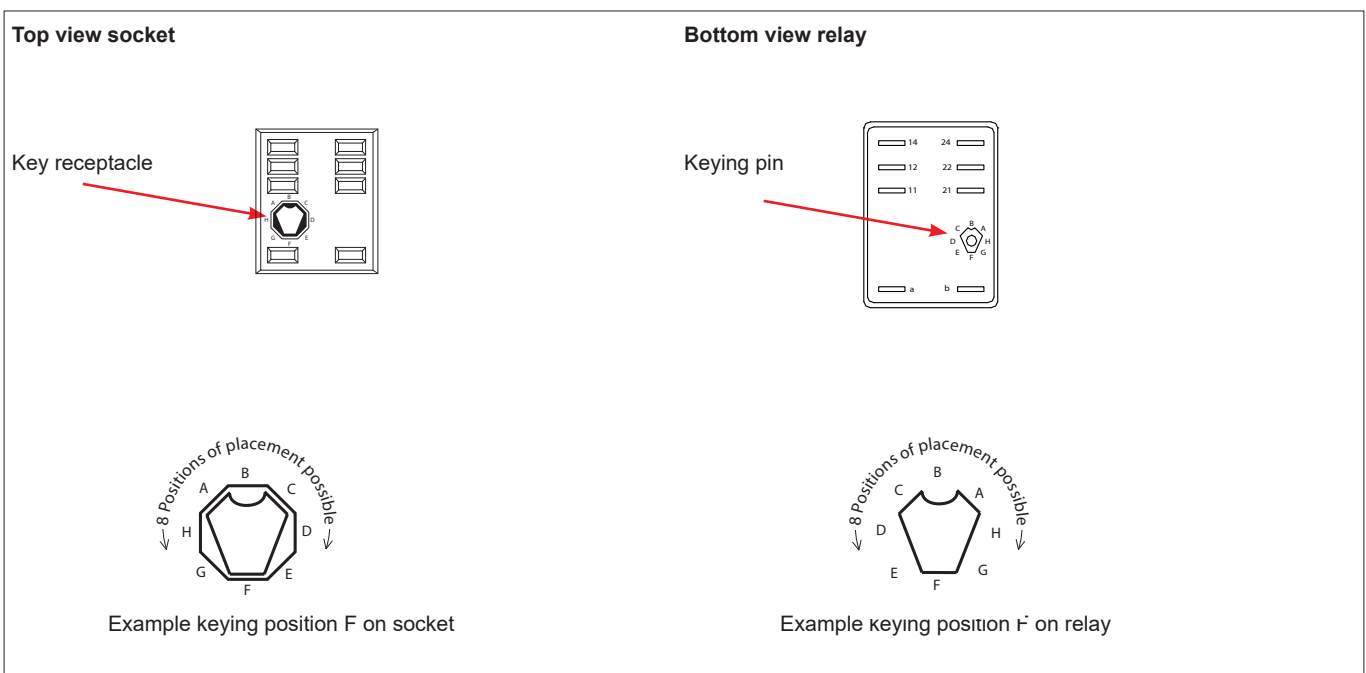

Instantaneous relay CU/CP-U900-I

Important for relay selection and operation

Make sure the relay is suitable for the application. For critical applications (for example: green loop applications) relays should be checked on correct working during periodic inspection.

Recommendations for long time contact reliability

For relays to enable failure free performance over a very long operational time, it is important to create the right circumstances. In any relay, contact usage and atmospheric conditions influence the contact surface. To counter this effect it is common practice to use a safety factor of > 2 to ensure long time contact reliability.

Therefore for long time contact reliability we recommend:

- Silver contacts: a minimum contact current of 20 mA per contact
- Gold contacts: a minimum contact current of 10 mA per contact
- Double Make Double Break contacts: a minimum contact current of 40 mA per contact
- When low currents are switched and not frequently, e.g. 10 mA once a day, it is advised next to gold plated contacts to put similar contacts within the same relay in parallel
- With higher load switching, e.g. 110 VDC and > 1 A, put relay contacts in series
- Rule of thumb: any relay works best with switching currents > 20 mA in DC environment when frequently switched. When not switched frequently a higher switching current like 50 mA is better for a long reliable operational time
- Check relays regularly, for example with the Mors Smitt Portable Relay Tester and visually through the transparent cover

Instructions for use

Installation

Before installation or working on the relay: disconnect the power supply first. Install socket and connect wiring according to the terminal identification. Plug relay into the socket ensuring there is no gap between the bottom of relay and the socket. Reverse installation into the socket is not possible due to the mechanical blocking of the standard keying inside CU-relays. Check to ensure that the coil connection polarity is not reversed. Relays can be mounted tightly together to save space.

Warning!

- Never use silicon in the proximity of the relays
- Do not use the relay in the presence of flammable gas as the arc generated from switching could cause ignition
- Relays should never be swapped to other circuit positions when taken out of its socket for inspection or fault finding, always place it back into the original position to prevent contact resistance problems. Contact resistance problems can be created when swapping relays between different circuit loads due to the contact wear/condition having changed during its operational life.

Operation

After installation always apply the rated voltage to the coil to check correct operation. Long term storage may corrode the silver on the relay pins. When plugging the relay into the socket, the female bifurcated or trifurcated receivers will automatically cut through the corrosion on the pins and guarantee a reliable connection.

Before actual use of relays, it is advised to switch the load several times with the contacts. The contacts will both be electrically and mechanically cleaned due to the positive wiping action. Sometimes a contact can build up increased contact resistance (≤ 15 m Ω when new). When using silver contacts one can clean the contact by switching a contact load a few times using >24 VDC & ~ 2 A. Increased contact resistance is not always problematic, as it depends on circuit conditions. In general a contact resistance of 1 Ω is no problem, consult Mors Smitt for more information.

Condensation in the relay is possible when the coil is energised (warm) and the outside, environmental temperature is cold. This is a normal phenomenon and will not affect the function of the relay. Materials in the relay have no hygroscopic properties.

Inspection / maintenance

Correct operation of the relay can easily be checked as the transparent cover provides good visibility of the moving contacts. If the relay does not seem to operate correctly, check for presence of the appropriate coil voltage and polarity using a suitable multimeter. If a LED is fitted, it indicates voltage presence to the coil. If coil voltage is present, but the relay does not operate, a short circuit of the suppression diode is possible (This may have been reversed due to the coil connection).

Relays can easily be tested with the Mors Smitt Relay Tester. More information on: www.morssmitt.com.

If the relay doesn't work after inspection, replace the relay unit with a similar model. Do not attempt to open the relay cover or try to repair. Contacts are calibrated and in balance, touching can affect proper operation. Also resoldering may affect correct operation. Since 2009 relays have tamper proof seals fitted and once broken, warranty is void.

Most relay defects are caused by installation faults such as overvoltage, spikes/transients, high/short current far exceeding the relay specifications. When returning the relays for investigation, please provide all information on the RMA form. Send defective relays back to the manufacturer for repair or replacement. Normal wear and tear or external causes are excluded from warranty.

RMA procedure see www.morssmitt.com

Instantaneous relay CU/CP-U900-I

Ordering scheme

C		- U9	- I	
Relay model	U			Plug-in model
	P			PCB model
Coil		03		0.39 ADC
		04		0.12 ADC
		08		4.4 ADC
		09		2.4 ADC
		10		1.5 ADC
		11		1.0 ADC
		12		0.6 ADC
		13		0.25 ADC
		14		0.18 ADC
		15		0.072 ADC
		52		1.0 AAC, 50/60 Hz
		54		0.27 AAC, 50/60 Hz
		55		1.2 AAC, 50/60 Hz
		58		2.4 AAC, 50/60 Hz
		59		1.5 AAC, 50/60 Hz
		60		0.6 AAC, 50/60 Hz
		61		0.38 AAC, 50/60 Hz
		62		0.18 AAC, 50/60 Hz
		63		0.072 AAC, 50/60 Hz
			A	Non-sinusoidal currents (AC only)
			E	Gold plated contacts

Upon ordering indicate keying if necessary.

Example: CU-U960-IA

Description: CU-U900 relay, Inom: 0.6 AAC 50/60 Hz, relay type I, non-sinusoidal currents

Instantaneous relay
CU/CP-U900-I

 **Over 10 million Mors Smitt relays in use in rail transport applications worldwide!**

Mors Smitt Asia Ltd.
Unit B & C, 25/F., Casey Aberdeen House,
38 Heung Yip Road, Wong Chuk Hang,
Hong Kong
Tel: +852 2343 555
sales.msa@wabtec.com

Mors Smitt France SAS
2 Rue de la Mandinière
72300 Sablé-sur-Sarthe, France
Tel: +33 (0) 243 92 82 00
sales.msf@wabtec.com

Mors Smitt UK Ltd.
Graycar Business Park,
Burton on Trent, DE13 8EN, UK
Tel: +44 (0)1283 357 263
sales.msuk@wabtec.com

Wabtec Netherlands
Darwinstraat 10,
6718 XR Ede, Netherlands
Tel: +31 (0)88 600 4500
sales.msbv@wabtec.com

Mors Smitt Technologies Ltd.
1010 Johnson Drive,
Buffalo Grove, IL 60089-6918, USA
Tel: +1 847 777 6497
salesmst@wabtec.com

RMS Mors Smitt
6 Anzed Court,
Mulgrave, VIC 3170, Australia
Tel: +61 (0)3 8544 1200
sales.rms@wabtec.com

(c) Copyright 2020

All rights reserved. Nothing from this edition may be multiplied, or made public in any form or manner, either electronically, mechanically, by photocopying, recording, or in any manner, without prior written consent from Mors Smitt. This also applies to accompanying drawings and diagrams. Due to a policy of continuous development Mors Smitt reserves the right to alter the equipment specification and description outlined in this datasheet without prior notice and no part of this publication shall be deemed to be part of any contract for the equipment unless specifically referred to as an inclusion within such contract. Mors Smitt does not warrant that any of the information contained herein is complete, accurate, free from potential errors, or fit for any particular purpose. Mors Smitt does not accept any responsibility arising from any party's use of the information in this document.