

/// CR Circuit breaker, hydraulic magnetic

Rugged circuit breaker for extreme reliability, within long endurance applications and harsh environments

CR Circuit breaker

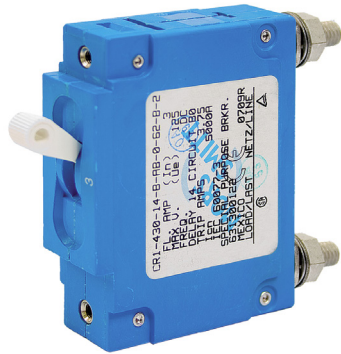

Features

- Precise, temperature independent operation
- Panel mount
- Integrated auxiliary contacts (optional)
- Up to 6 poles configuration
- High interrupting capacities due to unique arc chute method
- Mid-trip handle for electrical trip indication (optional)
- Immediate resetting possible
- Wide current range: 0.02 - 100 A
- Wide choice of time delays
- Maximum voltage 137.5 VDC / 484 VAC
- High contact pressure & longer contact life due to wiping self-cleaning contacts

Description

Compact hydraulic magnetic circuit breaker for railway applications, to protect electronic equipment and components against unintended high currents. Optional with integrated auxiliary contacts to monitor the circuit.

The trip point is always at maximum allowable current, independent of ambient temperature. Mid-trip handle to indicate clearly a breaker operation caused by electrical fault. With unique arc chute design which results in high interrupting capacities. Up to 6 poles which all break its electronic circuits when 1 breaker trips, for optimal protection of the system. Wide range of currents and options available.

Application

To be used in every application where electrical systems, circuits or components must be protected against too high currents. This situation can occur, when under strained or heavy use a motor or other load-generating component within the equipment will draw additional current from the power source. High currents cause the wires or components to overheat and ultimately burn up.

A circuit protection device should be employed at any point where a conductor size changes. Many electronic circuits and components like transformers have a lower overload withstand threshold level than conductors such as wires and cables. These components require circuit protection devices featuring very fast overload sensing and opening capabilities.

The CR-Series circuit breaker can be used in all Railway applications where protection against overload and short circuit is necessary, for example HVAC systems, (door) control systems, braking systems, passenger information systems, etc.



Railway compliancy

All our circuit breakers are designed according
EN 50155

IEC 60077 - 1/2/3/4 NF F 62-001 - 1/2/3

IEC 61373 NF F61-010

EN 50124-1 IEC 60068-2-30

EN 45545-2 IEC 60068-2-52

IEC 60947-2 MIL-STD-202G Method 107D, condition A

NF F16-101/102 MIL-STD-202G Method 106D

Circuit breaker CR

Technical specifications

Electrical characteristics

Application voltage	DC for 1-6 poles	AC for 1 pole	AC for 2-6 poles
Rated voltage	12 - 110 VDC	12 - 230 VAC	12 - 400 VAC
Min. operating voltage	8.4 VDC	10.8 VAC	10.8 VAC
Max. operating voltage	137.5 VDC	253 VAC	484 VAC
	Remark: 8.4 - 125 VDC: max 100 A 125 - 137.5 VDC: max 70 A		
Current ratings	0.02 - 100 A (other ratings on request)		
Voltage coils	6 VDC - 65 VDC / 6 VAC - 240 VAC (other ratings on request)		
Dielectric strength	5000 VAC, 50/60 Hz for 1 minute between all electrically isolated terminals		
Creepage and clearance	EN 50124-1 8 mm spacing requirements from hazardous voltage to operator accessible surfaces, between adjacent poles and from main circuits to auxiliary circuits		
Insulation resistance	Minimum of 100 MΩ @ 500 VDC		
Operating frequency	50/60 Hz, DC		
Max. interrupting cap.	IEC 60077	5000 A @ 125 VDC, 1 - 70 A 4500 A @ 415 VAC, 1 - 60 A 4000 A @ 415 VAC, 61 - 100 A	
	IEC 60947-2	6000 A @ 240 VAC, 1 - 70 A 4500 A @ 240 VAC, 71 - 100 A 6000 A @ 415 VAC, 1 - 30 A 4500 A @ 415 VAC, 31 - 70 A	
	IEC 60934	5000 A @ 80 VDC, 0.1 - 100 A 5000 A @ 125 VDC, 1 - 60 A 5000 A @ 250 VAC, 0.1 - 100 A	
	UL 489	10000 A @ 80 VDC, 1 - 100 A	
Auxiliary switch	Integrated, load side. SPST. Auxiliary switch senses the on-off position of circuit breaker handle, as well as the open-closed position of breaker contact.		
		Silver auxiliary contacts	Gold auxiliary contacts
AC min. switching cap.		5 - 20 VAC: 100 mA ≥ 20 VAC: 10 mA	5 mA / 5 VAC
AC max. switching cap.		5 A / 125 VAC	100 mA / 125 VAC
DC min switching cap.		≤ 20 VDC: 100 mA ≥ 20 VDC: 10 mA	5 mA / 5 VDC
DC max. switching cap.		3 A / 32 VDC 100 mA / 125 VDC (max. 2000 cycles)	100 mA / 32 VDC 2 mA / 110 VDC (max. 2000 cycles)
	All loads mentioned are resistive loads.		

Circuit breaker

CR

General characteristics

Number of poles	1, 2, 3, 4, 5 or 6 poles For DC and AC applications: 1-2 poles \leq 100 A 3-6 poles \leq 70 A																											
Terminals	Stud / screw / double faston	See circuit & terminal diagrams.																										
Auxiliary contacts	Faston or solder type	See circuit & terminal diagrams.																										
Mounting	The hydraulic-magnetic circuit breakers of Mors Smitt can be mounted in any position. A hydraulic-magnetic breaker is designed to "must hold" at 100% of the breaker's current rating and is calibrated to "must trip" at 125% of the breaker's current rating. If the mounting position is +90 degrees from a vertical panel mount (handle facing down, ceiling mount position) the trip and must hold rating is reduced by approximately 10%.																											
Body	Blue colour																											
Actuator	Several colours "I O" and/or "On-off" legends																											
Int. circuit configuration	Series trip, shunt trip, relay trip & switch only																											
Weight (typical)	<table border="0"> <tr><td>1-pole without aux. contact</td><td>101 g</td></tr> <tr><td>2-pole without aux. contact</td><td>202 g</td></tr> <tr><td>3-pole without aux. contact</td><td>303 g</td></tr> <tr><td>4-pole without aux. contact</td><td>404 g</td></tr> <tr><td>5-pole without aux. contact</td><td>505 g</td></tr> <tr><td>6-pole without aux. contact</td><td>606 g</td></tr> <tr><td colspan="2"> </td></tr> <tr><td>1-pole with aux. contact</td><td>104 g</td></tr> <tr><td>2-pole with aux. contact</td><td>205 g</td></tr> <tr><td>3-pole with aux. contact</td><td>306 g</td></tr> <tr><td>4-pole with aux. contact</td><td>407 g</td></tr> <tr><td>5-pole with aux. contact</td><td>508 g</td></tr> <tr><td>6-pole with aux. contact</td><td>609 g</td></tr> </table>		1-pole without aux. contact	101 g	2-pole without aux. contact	202 g	3-pole without aux. contact	303 g	4-pole without aux. contact	404 g	5-pole without aux. contact	505 g	6-pole without aux. contact	606 g			1-pole with aux. contact	104 g	2-pole with aux. contact	205 g	3-pole with aux. contact	306 g	4-pole with aux. contact	407 g	5-pole with aux. contact	508 g	6-pole with aux. contact	609 g
1-pole without aux. contact	101 g																											
2-pole without aux. contact	202 g																											
3-pole without aux. contact	303 g																											
4-pole without aux. contact	404 g																											
5-pole without aux. contact	505 g																											
6-pole without aux. contact	606 g																											
1-pole with aux. contact	104 g																											
2-pole with aux. contact	205 g																											
3-pole with aux. contact	306 g																											
4-pole with aux. contact	407 g																											
5-pole with aux. contact	508 g																											
6-pole with aux. contact	609 g																											
Width per pole	19.2 mm																											
Material	Half shell - BMC 605 Handle - Valox 420SEO UL94V0 Terminals - Brass with acid tin plate																											

Circuit breaker CR

Mechanical characteristics

Endurance	20.000 ON-OFF operations @ 6 per minute without current & voltage. 10.000 ON-OFF operations with rated current & voltage.
Trip free mechanism	Trips on short-circuit or on overload, even when actuator is forcibly held in the ON position.
Trip indication: Standard (no mid-trip)	When manually moving the operating handle from OFF to ON position, an auxiliary switch is actuated. When an overload or a short circuit causes the circuit breaker to trip, the operating handle moves positively to the OFF position and the auxiliary switch is actuated.
Mid-trip	When manually moving the operating handle from OFF to ON position, an auxiliary switch is actuated. When an overload or a short circuit causes the circuit breaker to trip, the operating handle moves positively to the mid position and the auxiliary switch is actuated.
Mid-trip with alarm switch	When manually moving the operating handle from OFF to ON position, an auxiliary switch is not actuated. When an overload or a short circuit causes the circuit breaker to trip, the operating handle moves positively to the mid position and the auxiliary switch is actuated. In this case the auxiliary switch is only actuated by an electrical trip, not by manually operating the handle. Remark: It is possible to manually switch the circuit breaker to the mid-trip position when the handle is switched from OFF to ON position quickly and with strong upwards force. Normally this won't occur in standard use. This is a normal phenomenon related to the design of the product.

Environmental characteristics

Environmental	Complies to EN 50125-1 and IEC 60077-1
Operating temperature	-50 °C...+85 °C
Vibration	IEC 61373, Category 1, class B body mounted
Shock	IEC 61373, Category 1, class A & B body mounted
Thermal shock	Complies to MIL-107D method, test condition A
Salt mist	Complies to IEC 60068-2-52 severity level 3
Damp heat	Complies to IEC 60068-2-30 test method Db variant 1
Fire & smoke	Complies to NF F 16101, NF F 16102, EN 45545-2:HL3 for requirements R22, R23, R26
Protection	IEC 60529, IP40 when a panel is mounted over the circuit breaker; when no panel is mounted IP20
Moisture resistance / humidity	Complies to MIL-STD 202G method

Circuit breaker CR

Resistance, impedance

Resistance, impedance values from Line to Load terminals
(Values based on series trip circuit breaker)

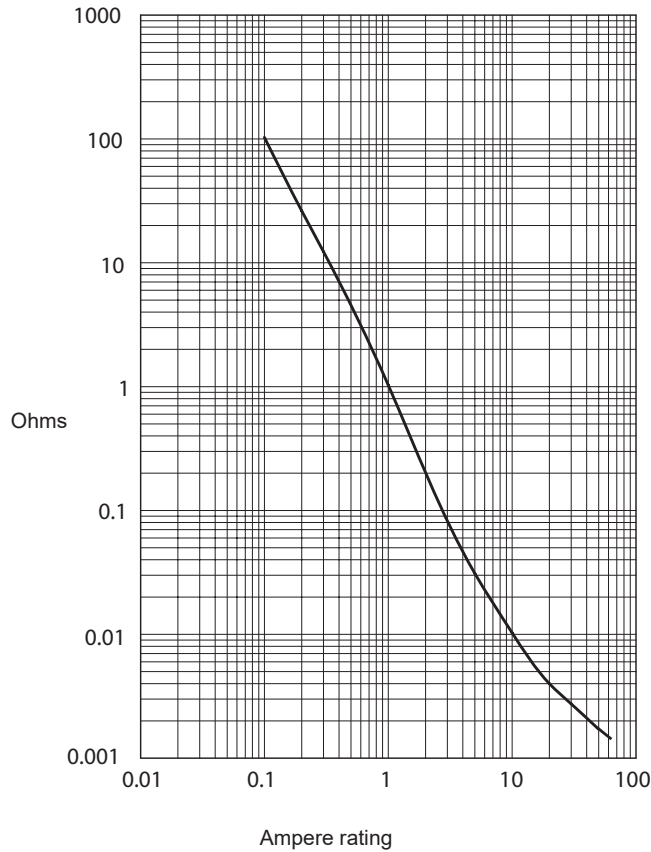

Current (amps)	Tolerance (%)
0.10 - 5.0	± 15%
5.1 - 20.0	± 25%
20.1 - 100.0	± 35%

Inrush pulse tolerance

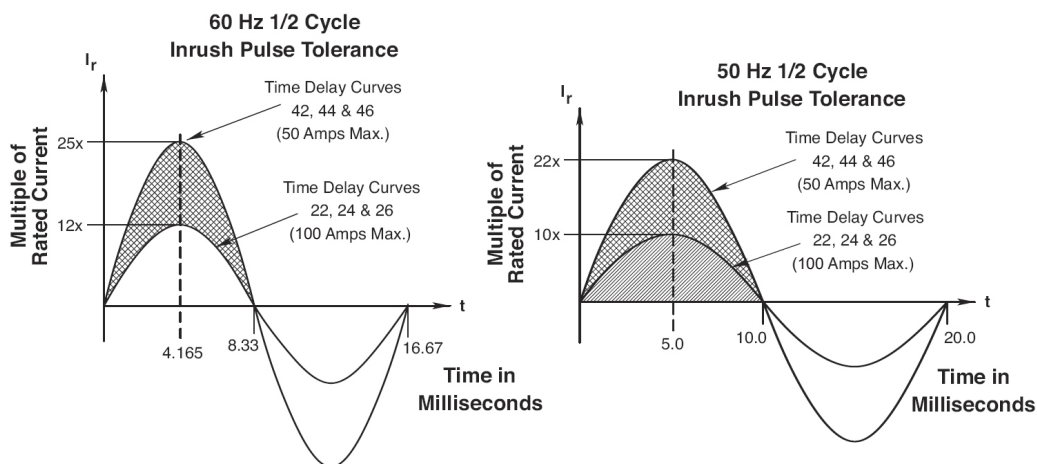

Circuit breaker CR

Table of time delay values

TRIP TIME (SECONDS)	PERCENT OF RATED CURRENT										
	DELAY	100%	125%	135%	150%	200%	400%	600%	800%	1000%	1200%
10	No Trip	May Trip	---	.032 MAX	.024 MAX	.020 MAX	.018 MAX	.016 MAX	.015 MAX	.013 MAX	.013 MAX
11	No Trip	.013 - .125	---	.010 - .070	.008 - .032	.006 - .020	.005 - .020	.004 - .020	.004 - .020	.004 - .020	.004 - .020
12	No Trip	.500 - 6.50	---	.300 - 3.00	.130 - 1.20	.031 - .220	.011 - .120	.004 - .090	.004 - .060	.004 - .040	.004 - .040
14	No Trip	2.00 - 60.0	---	1.20 - 40.0	.600 - 20.0	.150 - 3.00	.030 - 1.30	.004 - .600	.004 - .100	.004 - .100	.004 - .100
16	No Trip	45.0 - 345	---	20.0 - 150	9.00 - 60.0	1.40 - 11.4	.150 - 5.80	.009 - 3.70	.005 - 1.70	.005 - 1.70	.005 - 1.70
20	No Trip	May Trip	---	.040 MAX	.035 MAX	.030 MAX	.025 MAX	.020 MAX	.017 MAX	.015 MAX	.015 MAX
21	No Trip	.014 - .150	---	.011 - .095	.008 - .055	.006 - .035	.005 - .027	.005 - .021	.004 - .018	.004 - .017	.004 - .017
22	No Trip	.700 - 12.0	---	.350 - 4.00	.130 - 1.30	.027 - .220	.008 - .130	.004 - .090	.004 - .045	.004 - .040	.004 - .040
24	No Trip	10.0 - 160	---	6.00 - 60.0	2.20 - 20.0	.300 - 3.00	.050 - 1.30	.007 - .500	.005 - .060	.005 - .040	.005 - .040
26	No Trip	50.0 - 700	---	32.0 - 350	10.0 - 90.0	1.50 - 15.0	.500 - 7.00	.020 - 3.00	.006 - 2.00	.005 - 1.00	.005 - 1.00
42	No Trip	.700 - 12.0	---	.400 - 6.00	.180 - 2.30	.050 - .600	.026 - .300	.018 - .200	.014 - .150	.012 - .130	.012 - .130
44	No Trip	7.00 - 100	---	3.00 - 50.0	1.10 - 18.0	.220 - 3.00	.120 - 1.70	.075 - 1.20	.050 - .850	.042 - .720	.042 - .720
46	No Trip	50.0 - 700	---	31.0 - 350	12.0 - 150	1.50 - 20.0	.700 - 10.0	.404 - 7.90	.260 - 6.50	.198 - 5.80	.198 - 5.80
52	No Trip	.500 - 6.50	---	.340 - 4.50	.180 - 2.30	.051 - .600	.030 - .320	.018 - .220	.014 - .200	.012 - .130	.012 - .130
54	No Trip	1.50 - 50.0	---	.750 - 35.0	.350 - 18.0	.110 - 3.00	.070 - 1.70	.045 - 1.40	.039 - 1.30	.035 - 1.30	.035 - 1.30
56	No Trip	45.0 - 345	---	19.0 - 170	8.50 - 100	1.24 - 15.0	.410 - 9.00	.256 - 8.00	.210 - 5.50	.198 - 2.90	.198 - 2.90

Notes:

- Delay curves 11, 12, 14, 16, 21, 22, 24, 26, 42, 44, 46, 52, 54, 56: Breakers to hold 100% and must trip at 125% of rated current and greater within the time limit shown in this curve
- Delay curves 10, 20: Breakers to hold 100% and must trip at 150% of rated current and greater within the time limit shown in this curve
- All curves: Curve data shown represents breaker response at ambient temperature of 25 °C (77 °F) with no preloading. Breakers are mounted in standard wall-mount position. Delay times may vary at different temperature, the trip current rating remains unchanged
- On 50 amp and less current ratings, the minimum inrush pulse tolerance handling capability is 12 times the rated current on standard delays and 25 times the rated current on high inrush delays. These values are based on a 60 Hz 1/2 cycle, 8.33 ms pulse. High inrush delays should be specified for applications with high initial surge currents of short duration such as switching power supplies, highly capacitive loads and transformer loads

Circuit breaker CR

Time delay values

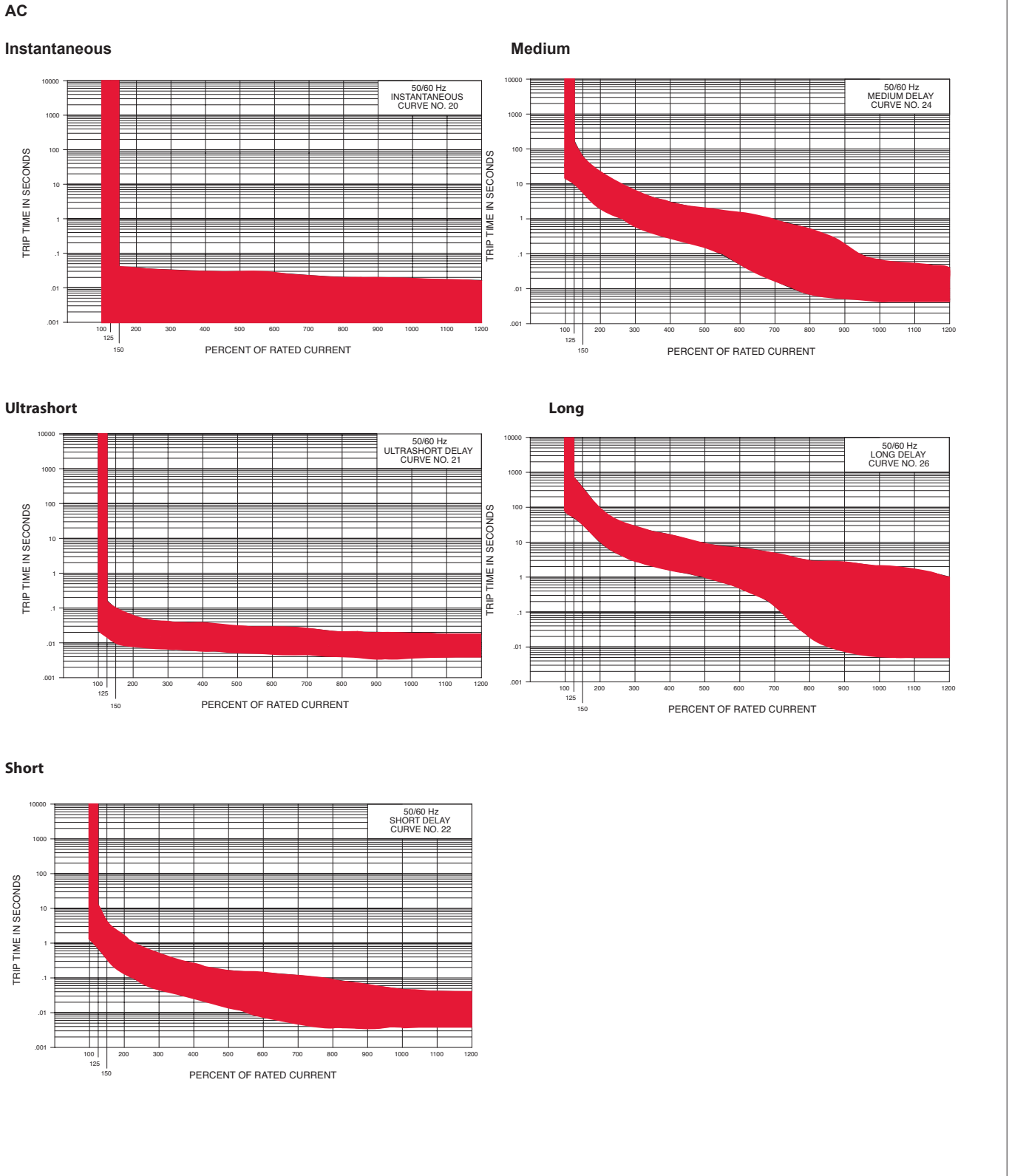

Circuit breaker CR

Time delay values

High Inrush AC

Short

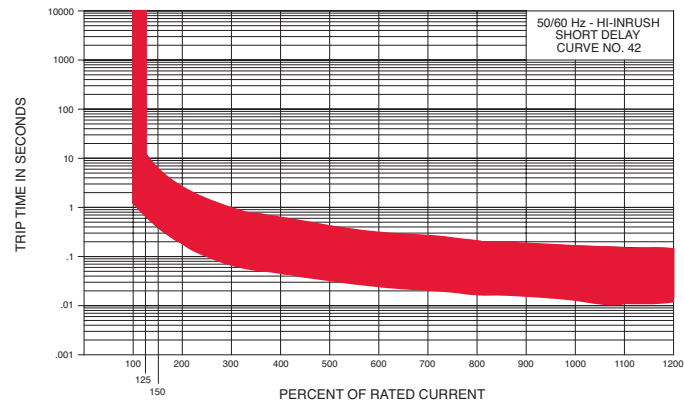

Medium

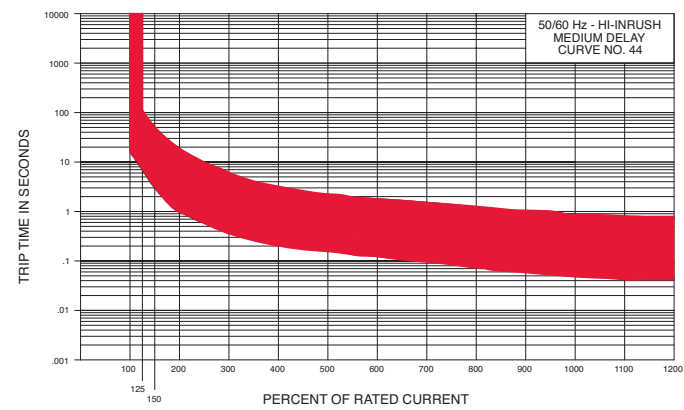

Long

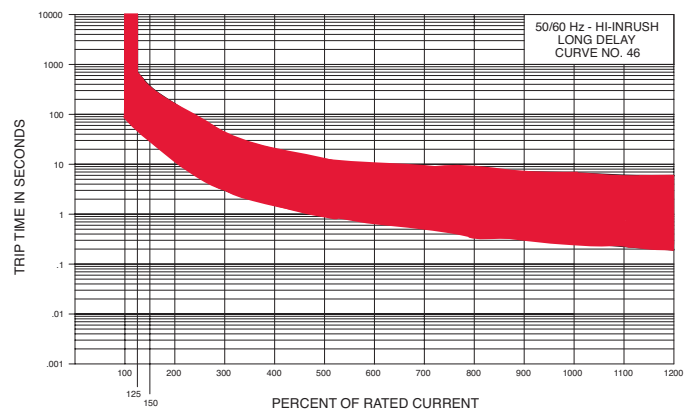

Circuit breaker CR

Time delay values

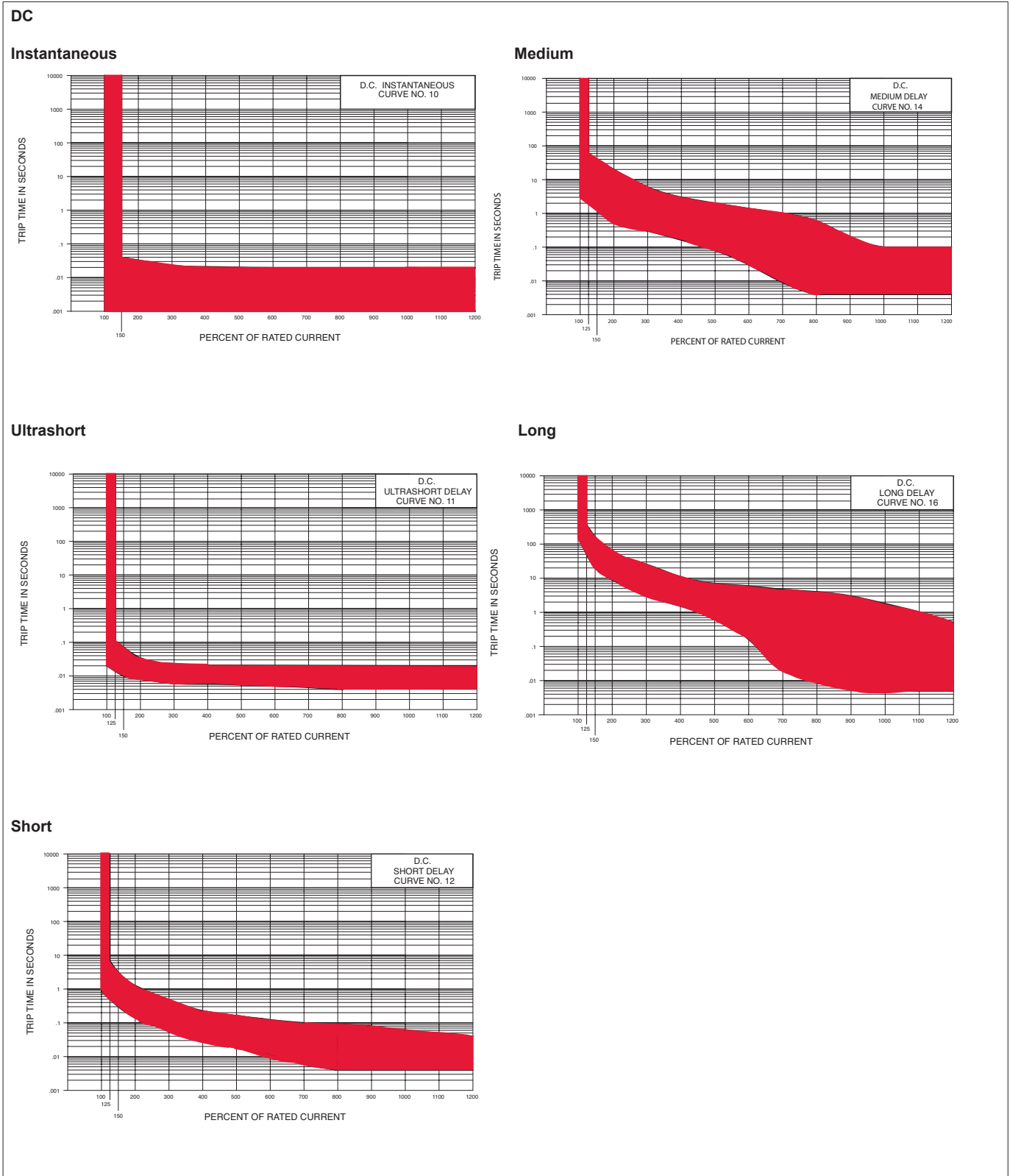

Circuit breaker CR

Time delay values

High Inrush DC

Short

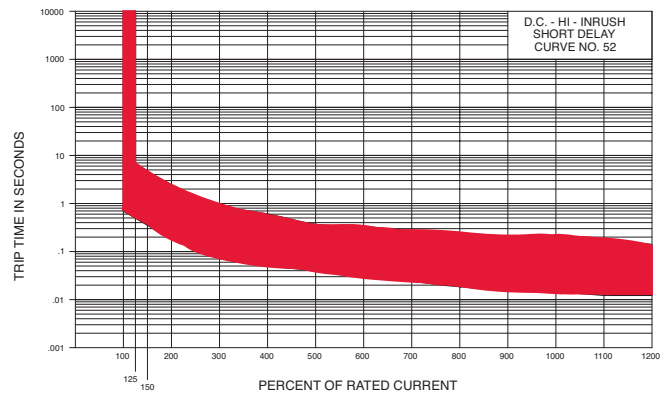

Medium

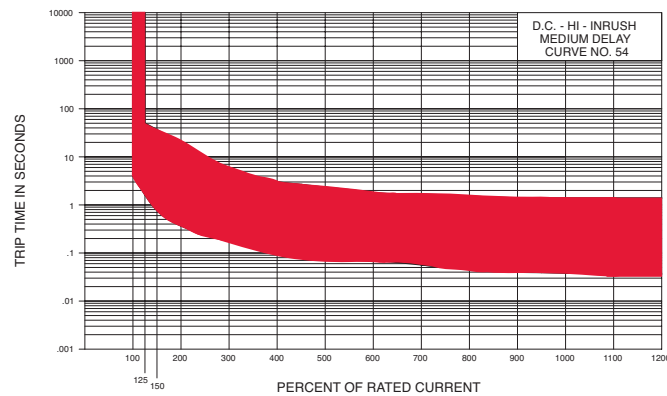

Long

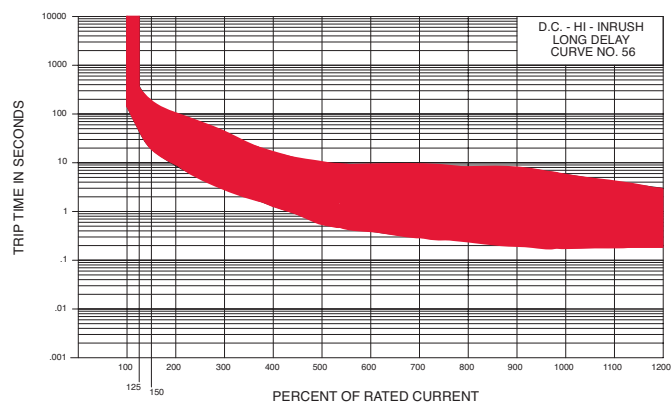

Circuit breaker CR

Circuit & terminal diagrams

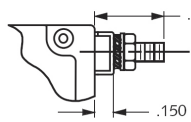
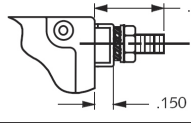
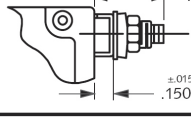
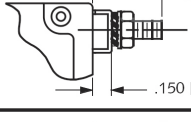
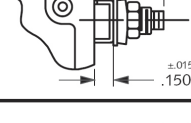
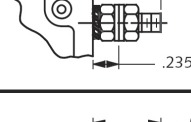
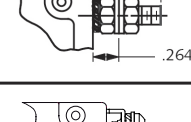
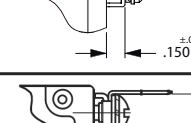
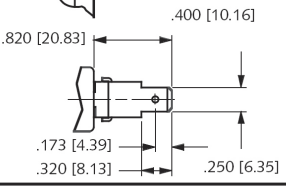
		TERMINAL		RATING (AMPS)		
DESCRIPTION	CODE	DIMENSIONAL DETAIL	25	50	100	
					80	
#10-32 STUD	1					
M5 STUD	4					
M5 STUD	R					
#1/4-20 STUD	3					
M6 STUD	6					
M6 STUD	5					
#1/4-20 STUD	3					
M6 STUD	6					
#10-32 SCREW	2					
M-5 SCREW	5					
.250 DOUBLE Q.C.	7					

Notes: 1. All dimensions are in inches [millimeters]
2. Tolerance on stud length $\pm .031$ [.79] unless otherwise specified

Circuit breaker CR

Circuit & terminal diagrams

Terminal hardware			
Description	Code	Ampere rating	Hardware supplied
#10-32 stud	1	.02 - 50	Flat washer - Lockwasher - Nut
M5 stud	4	.02 - 50	Flat washer - Lockwasher - Nut
#1/4 - 20 stud	3	.02 - 80	Flat washer - Lockwasher - Nut
		81 - 100	Lockwasher - Nut - (2) Flat washer - Lockwasher - Nut
M6 stud	6	.02 - 80	Flat washer - Lockwasher - Nut
		81 - 100	Lockwasher - Nut - (2) Flat washer - Lockwasher - Nut
#10-32 / M5	2 & 5	.02 - 50	Flat washer - Lockwasher - Screw
M5 stud	R	.02 - 50	SS flat washer per NFR 25 514 - Trepp or CS NFE 25 511 springwasher - self-locking nut per NFE 25 411
M6 stud	S	.02 - 80	SS flat washer per NFR 25 514 - Trepp or CS NFE 25 511 springwasher - self-locking nut per NFE 25 411

HANDLE POSITION VS. AUX/ALARM SWITCH MODE						
CIRCUIT BREAKER MODE	STANDARD C/B		MID TRIP C/B		MID TRIP C/B + ALARM SWITCH MODE	
	HANDLE POSITION	AUX. SWITCH MODE	HANDLE POSITION	AUX. SWITCH MODE	HANDLE POSITION	AUX. SWITCH MODE
OFF						
ON						
ELECTRICAL TRIP						

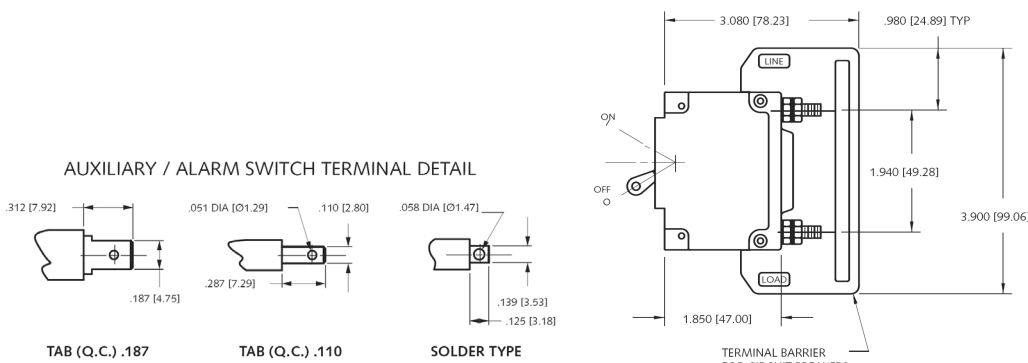

- Notes:
1. All dimensions are in inches [millimeters]
 2. Tolerance $\pm .020$ [.51] unless otherwise specified
 3. Available on Series Trip and Switch Only Circuits when called for on multi-pole units.
Only one aux. switch is normally supplied as viewed in multi-pole identification scheme.

Circuit breaker CR

Form & fit drawings

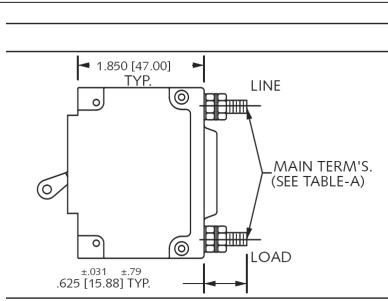
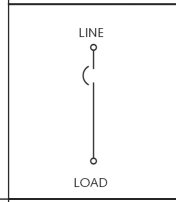
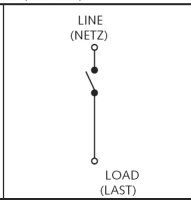
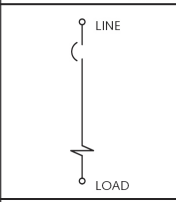
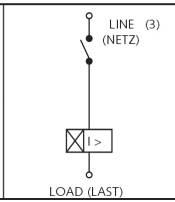
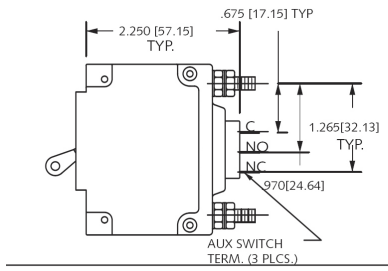
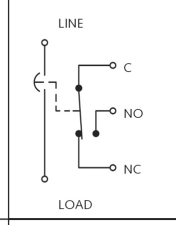
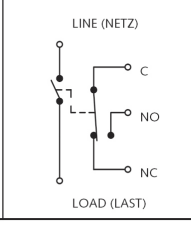
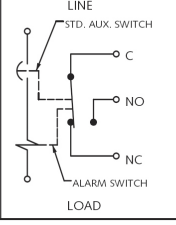
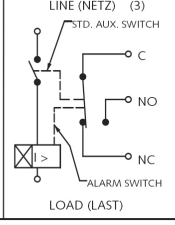
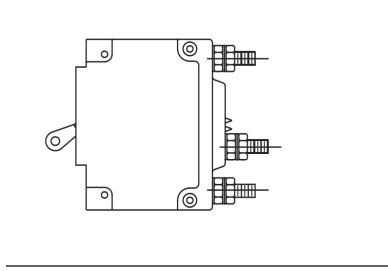
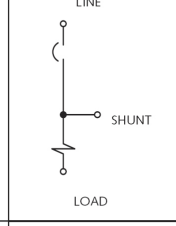
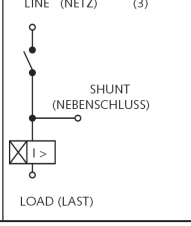
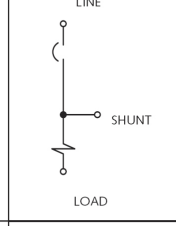
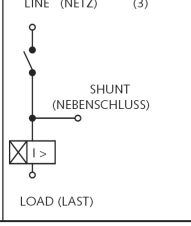
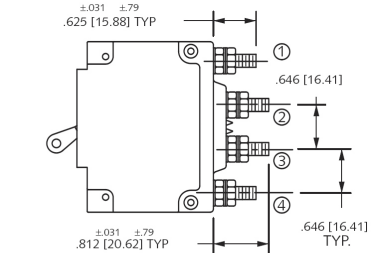
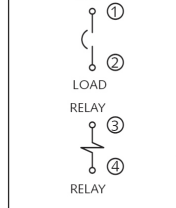
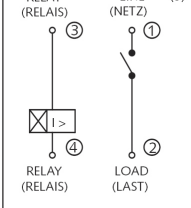
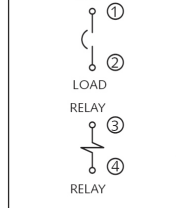
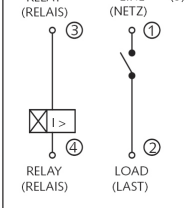
	CIRCUIT SCHEMATIC		CIRCUIT CODE	AUX. SWITCH CODE	CIRCUIT SCHEMATIC		CIRCUIT CODE	AUX. SWITCH CODE
	ANSI	IEC			ANSI	IEC		
	SWITCH ONLY (NO COIL)		A	O	SERIES TRIP		B C	O
								
	SWITCH ONLY (NO COIL) WITH AUXILIARY SWITCH		A	2 3 4	SERIES TRIP WITH AUXILIARY / ALARM SWITCH		B C	2 3 4
								
	SHUNT TRIP		D E					
								
	RELAY TRIP		F G					
								

TIGHTENING TORQUE SPECIFICATIONS	
THREAD SIZE	TORQUE
#6-32 [M3] MOUNTING INSERTS	max. 1.0 Nm
#10-32 & M5 THD STUDS	max. 2.3 Nm
#10-32 THD SCREW	max. 2.3 Nm
#1/4-20 & M6 THD STUDS	max. 4.0 Nm

- Notes:
1. All dimensions are in inches [millimeters]
 2. Tolerance ± 0.15 [0.38] unless otherwise specified
 3. Schematic shown represents current trip circuits

Circuit breaker CR

Form & fit drawings

1 pole configuration

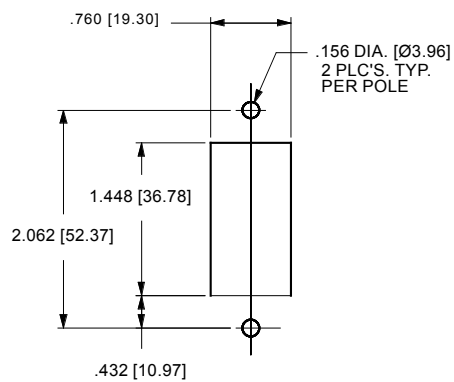
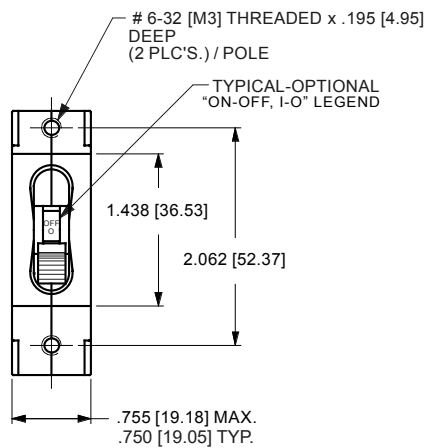
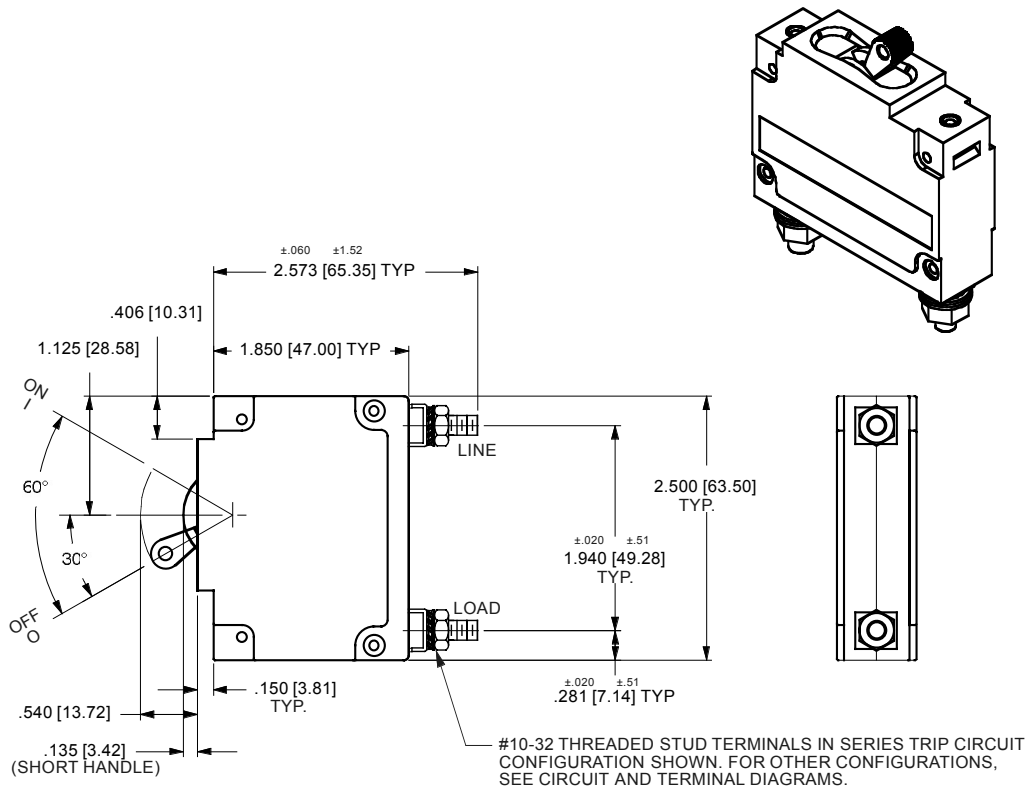

PANEL CUTOUT DETAIL
TOLERANCES ±.005 [.12]

- Notes:
1. All dimensions are in inches [millimeters]
 2. Tolerance ± 0.10 [0.25] unless otherwise specified

Circuit breaker CR

Form & fit drawings

2 pole configuration

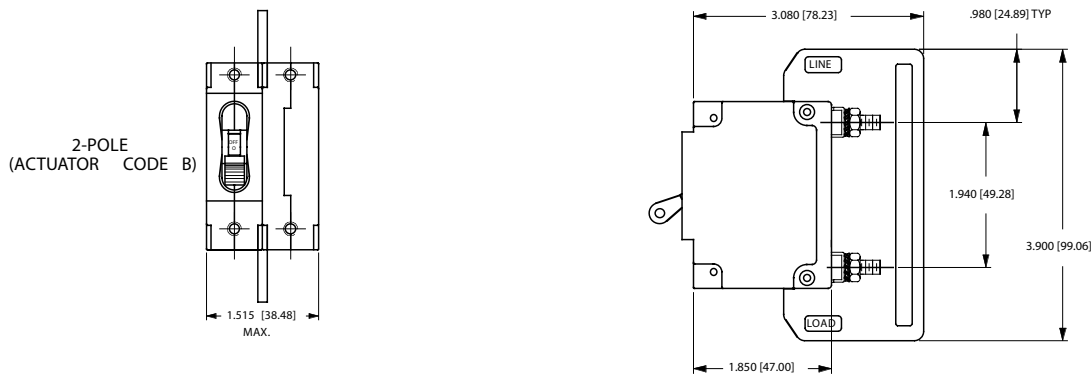
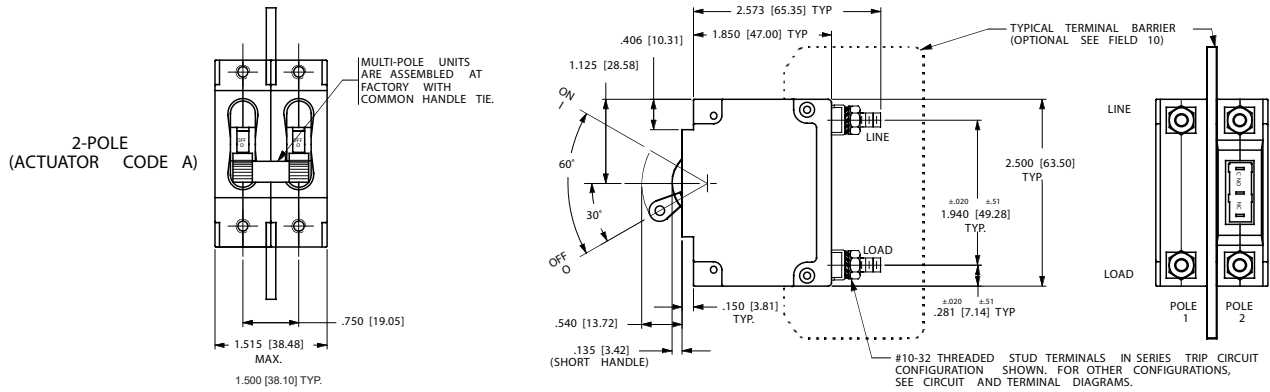

BARRIER FOR MULTI-POLE BREAKERS
Barrier with other dimensions on request

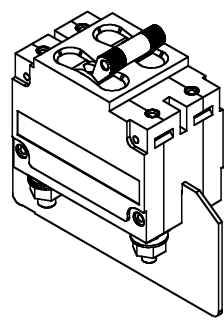
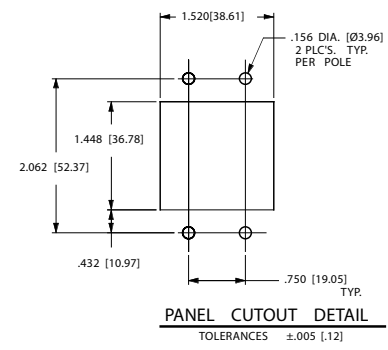

- Notes:
1. All dimensions are in inches [millimeters]
 2. Tolerance ± 0.10 [0.25] unless otherwise specified

Circuit breaker CR

Form & fit drawings

3 pole configuration

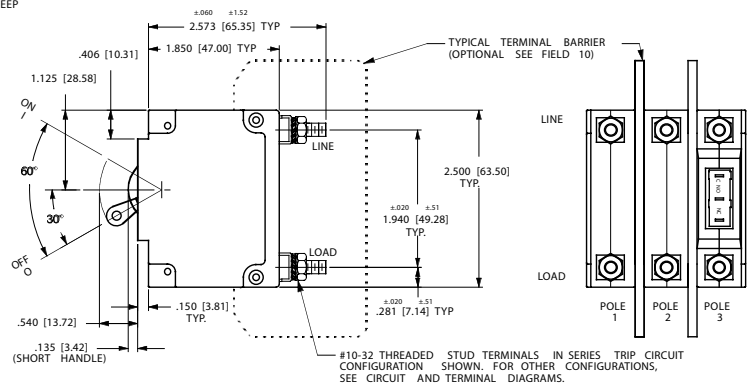
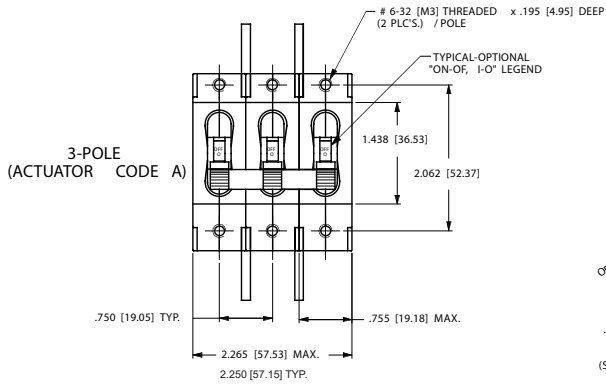

3-POLE (ACTUATOR CODE B)

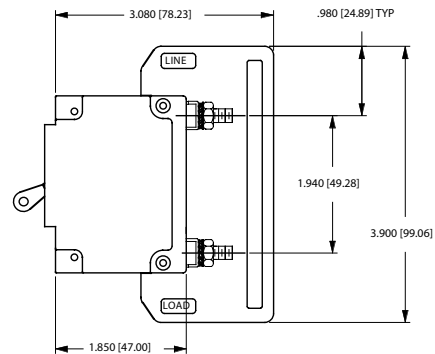
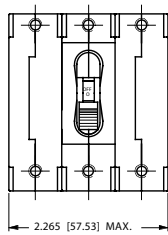

BARRIER FOR MULTI-POLE BREAKERS
Barrier with other dimensions on request

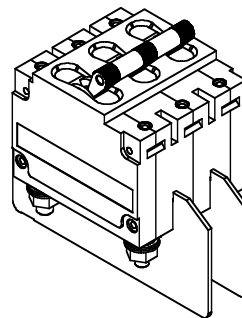
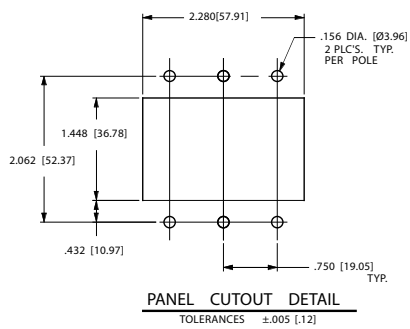

- Notes:
1. All dimensions are in inches [millimeters]
 2. Tolerance ± 0.10 [0.25] unless otherwise specified

Circuit breaker CR

Form & fit drawings

4 pole configuration

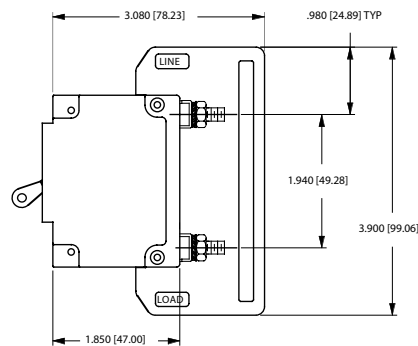
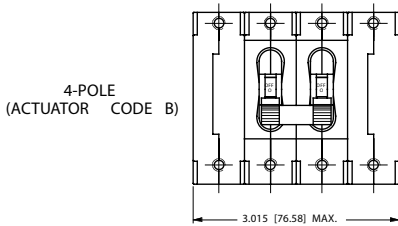
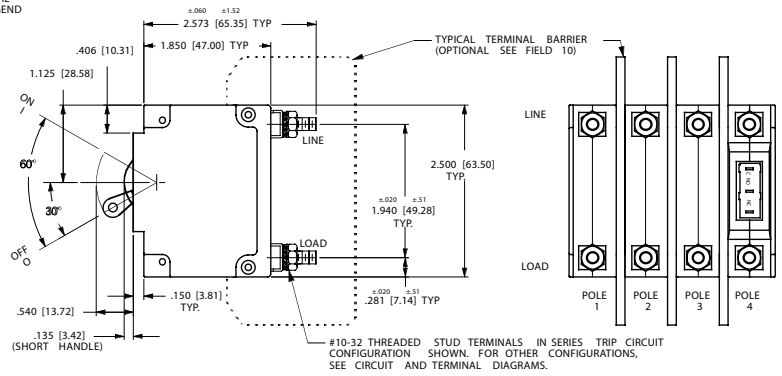
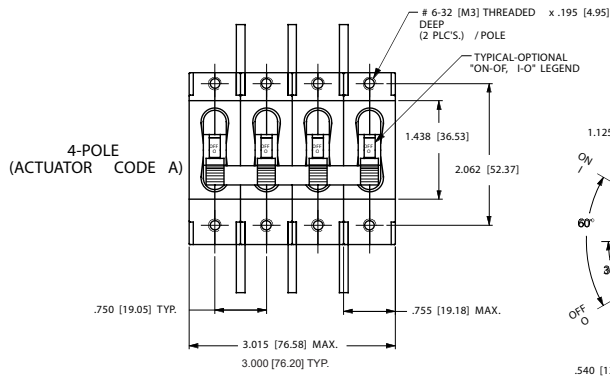

BARRIER FOR MULTI-POLE BREAKERS
Barrier with other dimensions on request

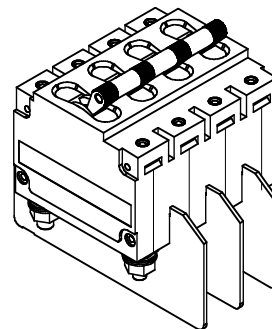
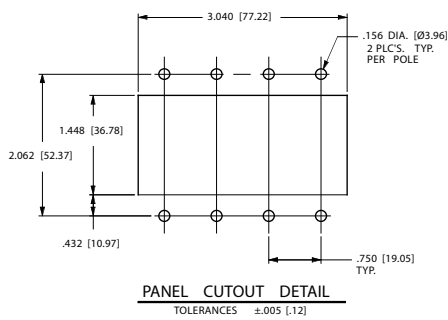

- Notes:
1. All dimensions are in inches [millimeters]
 2. Tolerance ± 0.10 [0.25] unless otherwise specified

Circuit breaker CR

Form & fit drawings

Short handle option

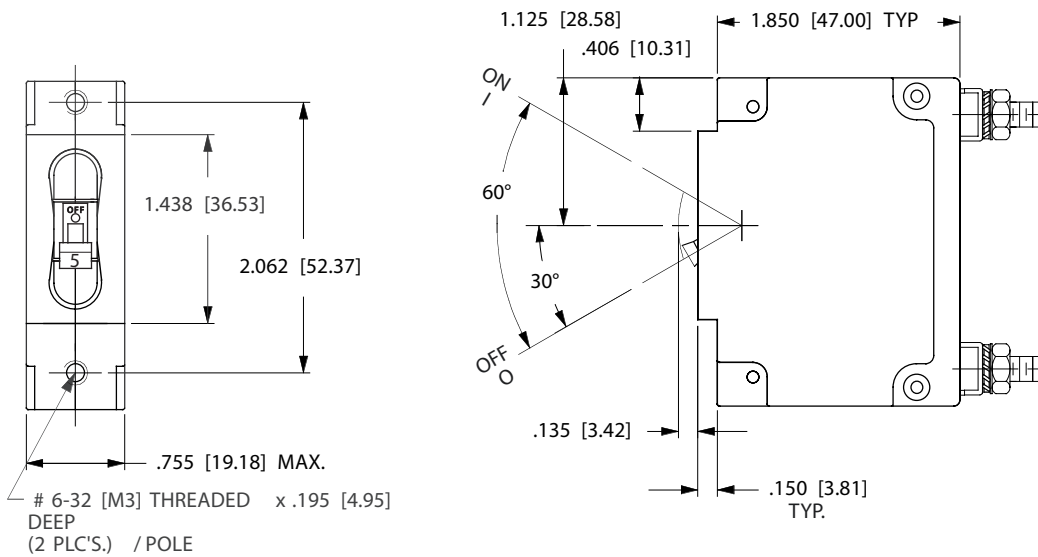

Rocker style actuator on request.

Auxiliary switch, 0.187 terminal

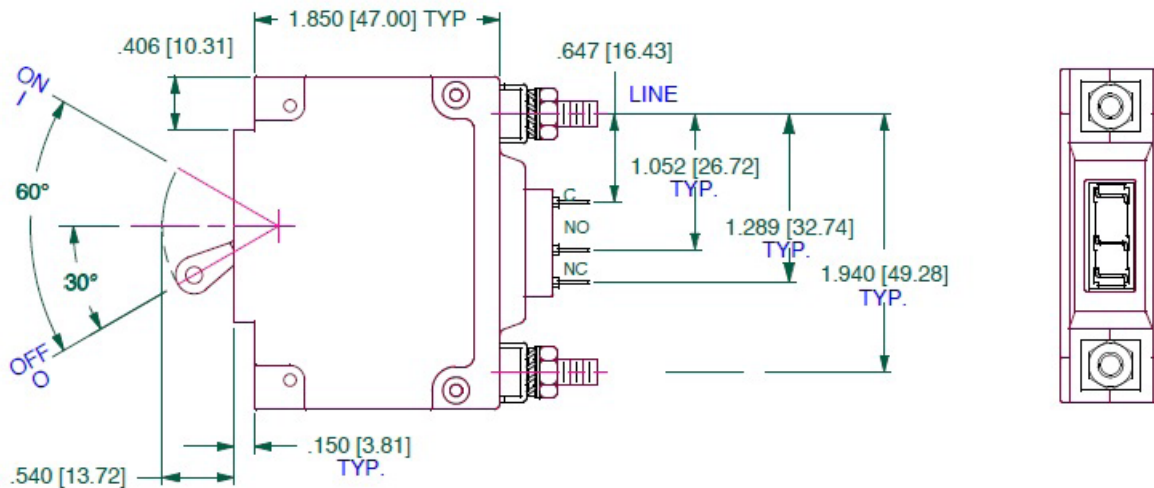

- Notes:
1. All dimensions are in inches [millimeters]
 2. Tolerance ± 0.10 [0.25] unless otherwise specified

Circuit breaker CR

Form & fit drawings

Auxiliary switch cover without shrouds

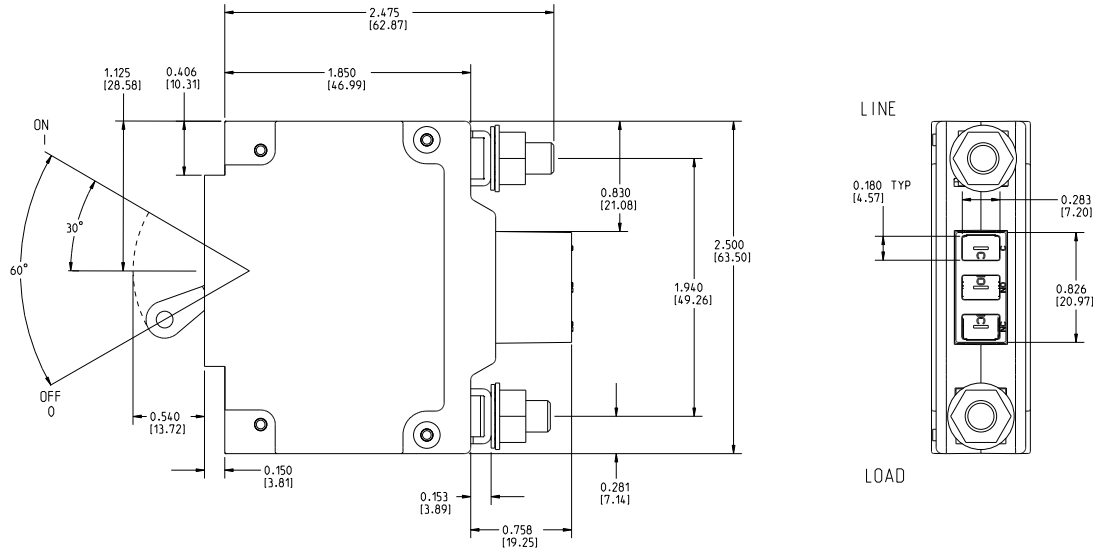

Auxiliary switch cover and shrouds on terminals option

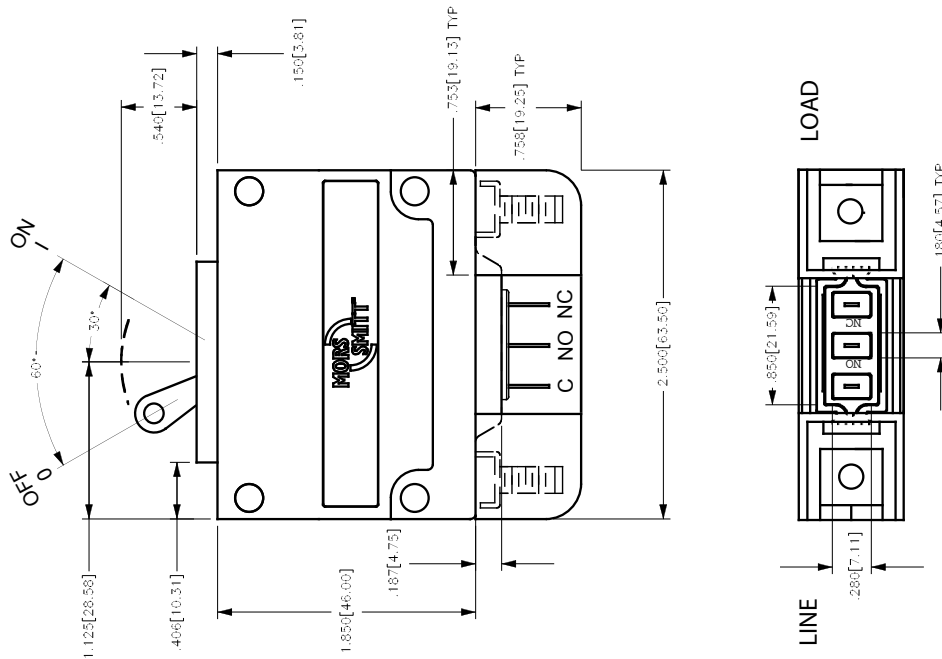

- Notes:
1. All dimensions are in inches [millimeters]
 2. Tolerance ± 0.10 [0.25] unless otherwise specified

Circuit breaker CR

Form & fit drawings

Busbar connection

To connect terminals of different CR-circuit breakers, busbars are available in different configurations. Contact Mors Smitt for more information.

Example: 3-phase busbar with 9 poles:

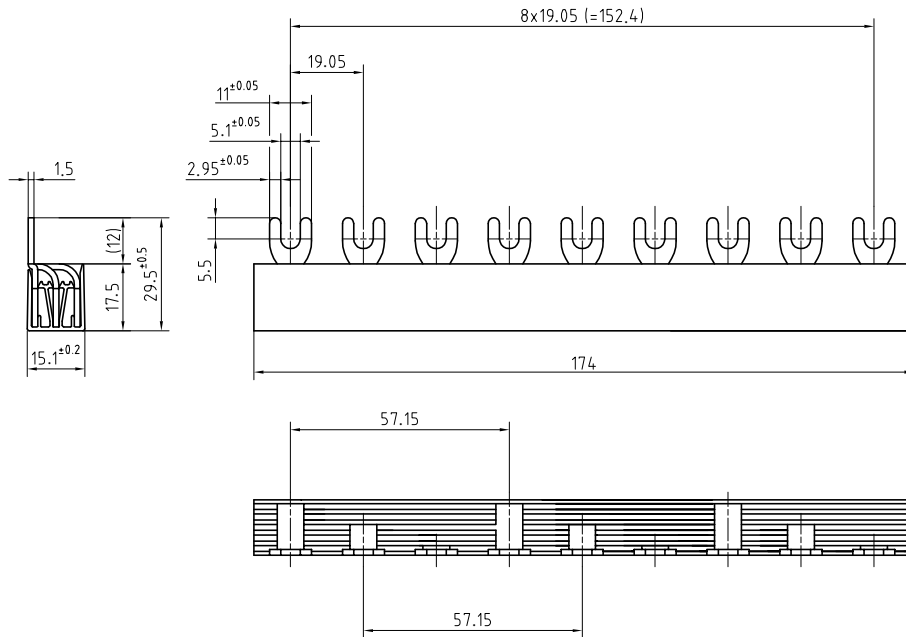

Notes: 1. All dimensions are in millimeters

Circuit breaker CR

Ordering scheme CR - page 1

CR		-	-	-codes continue on following page.....		
Poles ¹	1				1 pole		
	2				2 poles		
	3				3 poles		
	4				4 poles		
	5				5 poles		
	6				6 poles		
Current rating (amperes) ²	020		0.020	420	2.000	650	50.000
	025		0.025	522	2.250	660 ²	60.000
	030		0.030	425	2.500	670 ²	70.000
	035		0.035	527	2.750	680 ²	80.000
	040		0.040	430	3.000	690 ²	90.000
	045		0.045	435	3.500	695 ²	95.000
	050		0.050	440	4.000	810 ²	100.000
	055		0.055	445	4.500		
	060		0.060	450	5.000		
	065		0.065	455	5.500		Or voltage coil (nominal rated voltage) ³
	070		0.070	460	6.000	A06	6 DC
	075		0.075	465	6.500	A12	12 DC
	080		0.080	470	7.000	A18	18 DC
	085		0.085	475	7.500	A24	24 DC
	090		0.090	480	8.000	A32	32 DC
	095		0.095	485	8.500	A48	48 DC
	210		0.100	490	9.000	A65	65 DC
	215		0.150	495	9.500		
	220		0.200	610	10.000	J06	6 AC
	225		0.250	710	10.500	J12	12 AC
	230		0.300	611	11.000	J18	18 AC
	235		0.350	711	11.500	J24	24 AC
	240		0.400	612	12.000	J48	48 AC
	245		0.450	712	12.500	J65	65 AC
	250		0.500	613	13.000	K20	120 AC
	255		0.550	614	14.000	L40	240 AC
	260		0.600	615	15.000		
	265		0.650	616	16.000		
	270		0.700	617	17.000		
	275		0.750	618	18.000		
	280		0.800	620	20.000		
	285		0.850	622	22.000		
	290		0.900	624	24.000		
	295		0.950	625	25.000		
	410		1.000	630	30.000		
	512		1.250	632	32.000		
415		1.500	635	35.000			
(Over values on request)	517		1.750	640	40.000		
Frequency & delay	03 ⁴						DC, 50/60 Hz, switch only
	10						DC instantaneous
	11						DC ultra short
	12						DC short
	14						DC medium
	16						DC long
	20						50/60 Hz instantaneous
	22						50/60 Hz short
	24						50/60 Hz medium
	26						50/60 Hz long
	42 ⁵						50/60 Hz short, hi-inrush
	44 ⁵						50/60 Hz medium, hi-inrush
	46 ⁵						50/60 Hz long, hi-inrush
52 ⁵						DC, short, hi-inrush	
54 ⁵						DC, medium, hi-inrush	
56 ⁵						DC, long, hi-inrush	

Circuit breaker

CR

Ordering scheme CR - page 2

Circuit	A ⁴ B C D ⁶ E ^{6,18} F ^{6,18} G ^{6,18}								Switch only (no coil) Series trip (current) Series trip (voltage) Shunt trip (current) Shunt trip (voltage) Relay trip (current) Relay trip (voltage)																																																		
Actuator ⁷	A B S T								Handle, one per pole Handle, one per multiple unit Mid-trip handle, one per pole Mid-trip handle, one per pole & alarm switch																																																		
Actuator colour & legend	..								<table border="1"> <thead> <tr> <th>Actuator colour</th> <th>I-O</th> <th>On-Off</th> <th>Dual</th> <th>Legend colour</th> </tr> </thead> <tbody> <tr><td>White</td><td>A</td><td>B</td><td>1</td><td>Black</td></tr> <tr><td>Black</td><td>C</td><td>D</td><td>2</td><td>White</td></tr> <tr><td>Red</td><td>F</td><td>G</td><td>3</td><td>White</td></tr> <tr><td>Green</td><td>H</td><td>J</td><td>4</td><td>White</td></tr> <tr><td>Blue</td><td>K</td><td>L</td><td>5</td><td>White</td></tr> <tr><td>Yellow</td><td>M</td><td>N</td><td>6</td><td>Black</td></tr> <tr><td>Grey</td><td>P</td><td>Q</td><td>7</td><td>Black</td></tr> <tr><td>Orange</td><td>R</td><td>S</td><td>8</td><td>Black</td></tr> <tr><td>White (short handle)¹⁸</td><td>V</td><td>W</td><td>0</td><td>Black</td></tr> </tbody> </table>	Actuator colour	I-O	On-Off	Dual	Legend colour	White	A	B	1	Black	Black	C	D	2	White	Red	F	G	3	White	Green	H	J	4	White	Blue	K	L	5	White	Yellow	M	N	6	Black	Grey	P	Q	7	Black	Orange	R	S	8	Black	White (short handle) ¹⁸	V	W	0	Black
Actuator colour	I-O	On-Off	Dual	Legend colour																																																							
White	A	B	1	Black																																																							
Black	C	D	2	White																																																							
Red	F	G	3	White																																																							
Green	H	J	4	White																																																							
Blue	K	L	5	White																																																							
Yellow	M	N	6	Black																																																							
Grey	P	Q	7	Black																																																							
Orange	R	S	8	Black																																																							
White (short handle) ¹⁸	V	W	0	Black																																																							
Auxiliary switch ⁸		0 2 3 4 9 A B							Without auxiliary switch SPDT, 0.110 QC term. SPDT, 0.139 solder lug SPDT, 0.110 QC term. (gold contacts) SPDT, 0.187 QC term. SPDT, 0.110 QC term. with cover SPDT, 0.110 QC term. (gold contacts) with cover																																																		
Terminal			1 ⁹ 2 ¹⁰ 3 ¹¹ 4 ¹⁰ R ¹⁰ T ¹⁰ U ¹⁰ 5 ¹⁰ 6 ¹¹ S ¹¹ V ¹¹ W ¹¹ 7 ¹²						Stud 10-32, threaded Screw 10-32 with saddle & washer clamps Stud 1/4-20, threaded Stud M5 x 0.8, threaded Stud M5 x 0.8, threaded with NFF washers and lockable nut Stud M5 x 0.8, threaded with shrouds Stud M5 x 0.8, threaded with NFF washers and lockable nut, with shrouds Screw M5 x 0.8 with saddle & washer clamp Stud M6 threaded Stud M6 threaded with NFF washers and lockable nut Stud M6 threaded with shrouds Stud M6 threaded with NFF washers and lockable nut, with shrouds Double quick terminal connection																																																		
Mounting & barriers				1 ¹⁹ A ¹⁹ 6 ¹⁹ 5 2 ¹⁹ F ¹⁹ 7 ¹⁹ 4					<table border="1"> <thead> <tr> <th>Mounting style</th> <th>Barriers</th> </tr> </thead> <tbody> <tr><td>Threaded insert</td><td></td></tr> <tr><td>6-32 x 0.195 inch</td><td>Yes, between poles only (multi pole)</td></tr> <tr><td>6-32 x 0.195 inch</td><td>Yes, between poles and at right side viewed from back (multi pole)</td></tr> <tr><td>6-32 x 0.195 inch</td><td>Yes, barrier at right side viewed from back (single pole)</td></tr> <tr><td>6-32 x 0.195 inch</td><td>No</td></tr> <tr><td>ISO M3 x 5 mm</td><td>Yes, between poles only (multi pole)</td></tr> <tr><td>ISO M3 x 5 mm</td><td>Yes, between poles and at right side viewed from back (multi pole)</td></tr> <tr><td>ISO M3 x 5 mm</td><td>Yes, barrier at right side viewed from back (single pole)</td></tr> <tr><td>ISO M3 x 5 mm</td><td>No</td></tr> </tbody> </table>	Mounting style	Barriers	Threaded insert		6-32 x 0.195 inch	Yes, between poles only (multi pole)	6-32 x 0.195 inch	Yes, between poles and at right side viewed from back (multi pole)	6-32 x 0.195 inch	Yes, barrier at right side viewed from back (single pole)	6-32 x 0.195 inch	No	ISO M3 x 5 mm	Yes, between poles only (multi pole)	ISO M3 x 5 mm	Yes, between poles and at right side viewed from back (multi pole)	ISO M3 x 5 mm	Yes, barrier at right side viewed from back (single pole)	ISO M3 x 5 mm	No																														
Mounting style	Barriers																																																										
Threaded insert																																																											
6-32 x 0.195 inch	Yes, between poles only (multi pole)																																																										
6-32 x 0.195 inch	Yes, between poles and at right side viewed from back (multi pole)																																																										
6-32 x 0.195 inch	Yes, barrier at right side viewed from back (single pole)																																																										
6-32 x 0.195 inch	No																																																										
ISO M3 x 5 mm	Yes, between poles only (multi pole)																																																										
ISO M3 x 5 mm	Yes, between poles and at right side viewed from back (multi pole)																																																										
ISO M3 x 5 mm	Yes, barrier at right side viewed from back (single pole)																																																										
ISO M3 x 5 mm	No																																																										
Maximum application rating					B C ¹³ D ¹⁴ J ¹⁵				125 VDC 120/240 VAC 240 VAC 415 VAC																																																		
Agency approval						2 A			TUV certified, UL recognized ¹⁷ No agency approvals (configuration not tested by external agency)																																																		

Example : CR1-610-14-B-A1-3-36-B-2

Circuit breaker CR

Notes:

1. Standard multipole units have all poles identical except when specifying auxiliary switch, mixed poles on request
2. Current rating 60 A - 100 A are available with circuit codes A & B only. Current ratings 80 A - 100 A are available up to 2 poles maximum
3. Voltage coils not rated for continuous duty. Available only with delay codes 10 and 20
4. For 0.02 to 30 A, select current code 630
For 30 - 50 A, select current code 650
For 60 - 70 A, select current code 670
For 80 - 100 A, select current code 810
Maximum number of poles on request
5. Available with circuit codes B & D only, and up to 50 A maximum
6. Circuit codes D, E, F & G available with terminal codes 1,2,4 & 5 only. Circuit codes D available up to 50 A maximum current rating
7. Actuator code:
 - B: Handle location as viewed from front of breaker:
 - 2 pole - left pole
 - 3 pole - center pole
 - 4 pole - two handles at center poles
 - 5 pole - three handles at center poles
 - 6 pole - four handles at center poles
 - S: Handle moves to mid-position only upon electrical trip of the breaker, available with all circuit codes except switch only
 - T: Handle moves to mid-position and alarm switch activates only upon electrical trip of the breaker, available with circuit codes B & C
8. Auxiliary switch available with series trip and switch only circuits. On multi-pole breakers, one auxiliary switch is supplied, mounted in the extreme right pole (rear view)
9. Available to 60 A maximum
10. Available to 50 A maximum
11. Available to 100 A maximum
12. Available to 25 A maximum
13. 2 & 3 pole circuit breakers required for 120/240 VAC applications, terminal barrier is required. Third pole is for 120/240 VAC applications requiring neutral disconnect. The 3rd pole has the same construction as poles 1 & 2.
14. Code only applicable for single pole. For multiple poles select code C
15. Multiple pole only
16. Single pole only
17. TUV certified: not for switch only circuit and not for actuator legend 'ON-OFF'
UL recognized: for most applications, not for all
UL listed: possible on request
Special applications without approvals: agency approval code A
18. Not TUV certified, agency approval code A
19. Barriers not in combination with terminal shrouds. When barrier is placed at the side the total width will increase with approximately 1.9 mm

Circuit breaker
CR

Mors Smitt Asia Ltd.
Unit B & C, 25/F., Casey Aberdeen House
38 Heung Yip Road, Wong Chuk Hang
Hong Kong
Tel: +852 2343 555
sales.msa@wabtec.com

Mors Smitt France SAS
2 Rue de la Mandinière
72300 Sablé-sur-Sarthe, France
Tel: +33 (0) 243 92 82 00
sales.msf@wabtec.com

Mors Smitt UK Ltd.
Graycar Business Park,
Burton on Trent, DE13 8EN, UK
Tel: +44 (0)1283 357 263
sales.msuk@wabtec.com

Wabtec Netherlands B.V.
Vrieslantlaan 6,
3526 AA, Utrecht, Netherlands
Tel: +31 (0)30 288 1311
sales.msbv@wabtec.com

Mors Smitt Technologies Ltd.
1010 Johnson Drive,
Buffalo Grove, IL 60089-6918, USA
Tel: +1 847 777 6497
salesmst@wabtec.com

RMS Mors Smitt
6 Anzed Court,
Mulgrave, VIC 3170, Australia
Tel: +61 (0)3 8544 1200
sales.rms@wabtec.com

(c) Copyright 2019

All rights reserved. Nothing from this edition may be multiplied, or made public in any form or manner, either electronically, mechanically, by photocopying, recording, or in any manner, without prior written consent from Mors Smitt. This also applies to accompanying drawings and diagrams. Due to a policy of continuous development Mors Smitt reserves the right to alter the equipment specification and description outlined in this datasheet without prior notice and no part of this publication shall be deemed to be part of any contract for the equipment unless specifically referred to as an inclusion within such contract. Mors Smitt does not warrant that any of the information contained herein is complete, accurate, free from potential errors, or fit for any particular purpose. Mors Smitt does not accept any responsibility arising from any party's use of the information in this document.