

# CK relay - safety critical, 9 contacts

## Datasheet

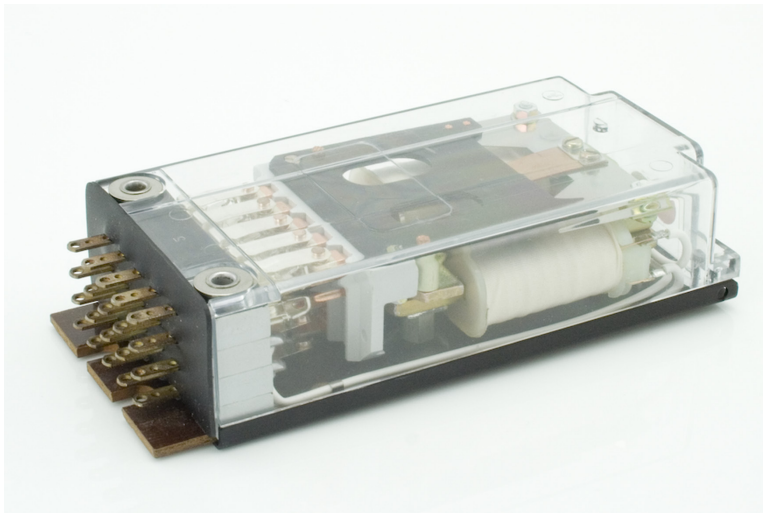

### Description

The CK safety critical, weld resistant and safety critical relay has 9 double break contacts (Form X & Y - per customers specification) in all NO and NC combinations. Weld no transfer and silver tin oxide safety contacts are standard. The plug-in design offers secure locking feature for maximum ease of maintenance (no wires need to be disconnected or other hardware removed for relay inspection or replacement).

The resistance to impact and vibration is conforming the standards for Railway Transported Equipment. Positive mechanical keying of relay to socket is built into relay and socket during manufacture and terminal identifications are clearly marked on identification plate that is permanently attached to the relay. In power interruption situation relay armature will assume a "safe" position whatever is the relay operating position due to the strength of the 1 compressed spring which pushes the armature back in the rest position.

The CK relays is pluggable in the COR NJ socket.

### Application

The CK relay is designed to offer ultra-compact space saving size for safety critical applications where a high degree of resistance to welding is required. Stationary contacts are silver tin oxide. Mobile contacts are hard silver laminated to copper.

#### Features

- Instantaneous relay
- Safety critical relay
- Weld resistant
- Weld no transfer safety contacts standard
- Plug-in design with secure locking feature
- 9 double break contacts in all NO and NC combinations
- Contact life (mechanical) of 100 million cycles
- -40°C to +80°C operating temperature

#### Benefits

- Proven reliable in heavy duty application
- Long life cycle
- Easy to maintain and replace
- Used in safety critical application
- Low life cycle cost

#### Railway compliancy

- NF F 62 - 002 Rolling stock - Instantaneous relays contacts and sockets
- NF F70-031 sec. 7.1.2 and 7.1.3 (for weld resistant contacts)
- NF F16-101/102 Fire behaviour - Railway rolling stock



# CK relay

## Technical specifications

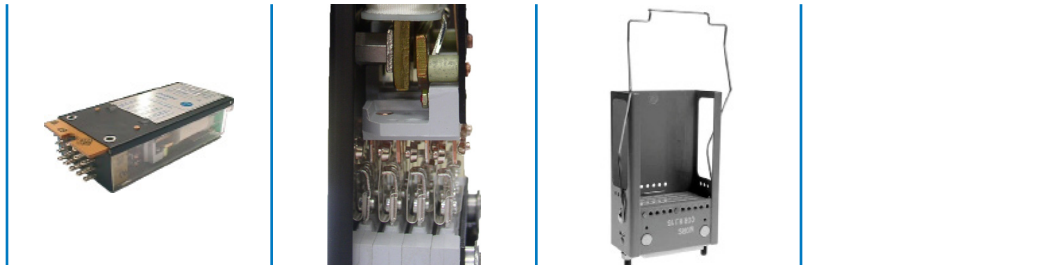

### Functional and connection diagrams

Timing diagram	Relay pin correspondence																														
	<p>Keying Plate</p> <table border="1"> <thead> <tr> <th></th> <th>0</th> <th>1</th> <th>2</th> <th>3</th> <th>4</th> </tr> </thead> <tbody> <tr> <td>A</td> <td>█</td> <td>█</td> <td>█</td> <td>█</td> <td>█</td> </tr> <tr> <td>B</td> <td>█</td> <td>█</td> <td>█</td> <td>█</td> <td>█</td> </tr> <tr> <td>C</td> <td>█</td> <td>█</td> <td>█</td> <td>█</td> <td>█</td> </tr> <tr> <td>D</td> <td>█</td> <td>█</td> <td>█</td> <td>█</td> <td>█</td> </tr> </tbody> </table> <p>Relay pin correspondence (rear view of relay shown)</p>		0	1	2	3	4	A	█	█	█	█	█	B	█	█	█	█	█	C	█	█	█	█	█	D	█	█	█	█	█
	0	1	2	3	4																										
A	█	█	█	█	█																										
B	█	█	█	█	█																										
C	█	█	█	█	█																										
D	█	█	█	█	█																										
Connection diagram																															
<p>Schematic #1</p>	<p>Schematic #2</p>																														
<p>Schematic #4</p>	<p>Schematic #5</p>																														
<p>Schematic #3</p>	<p>Schematic #6</p>																														



# CK relay

## Technical specifications

### Coil data – DC and AC versions

U <sub>nom</sub>	U <sub>operating</sub>	P <sub>nom</sub>	U <sub>Hold</sub>	U <sub>Drop-out</sub>	R coil (Ω) <sup>(1)</sup>	L/R (ms) <sup>(2)</sup>
24 VDC	16 / 33 VDC	4,8 W	13,5 VDC	2,5 VDC	120	25 ms
36 VDC	25 / 45 VDC	4,8 W	21 VDC	3,5 VDC	270	25 ms
48 VDC	33 / 60 VDC	4,6 W	28,5 VDC	4,5 VDC	500	25 ms
72 VDC	48 / 90 VDC	5,2 W	40,5 VDC	6,5 VDC	1000	25 ms
110 VDC	77 / 138 VDC	5 W	60 VDC	11,5 VDC	2400	25 ms
220 VAC	176 / 242 VAC	4 VA	129 VAC	21 VAC	12000	25 ms

(1) Coil resistance tol.: ± 8% at 20° C – (2) Valid for closed relay.

### Contact data – (AgSnO<sub>2</sub> contacts)

Nominal current	8 A resistive
Nominal breaking capacity and life	Please refer to derating curves.
Contact overload withstand	At 24 VDC: 160 A at L/R = 0 for 10 ms (10 operations at the rate of 1 operation per minute)
Contact closure time	Pick-up time NO < 45 ms      Drop-out* time NC: < 35 ms
Contact opening time	Pick-up time NC < 30 ms      Drop-out* time NO: < 8 ms
Minimum contact continuity	20 mA at 110 VDC and 100 mA at 24 VDC
Number of contacts	9 double make / double break contacts (form X & Y)
Contact material	Tin oxide (10%) stationary contacts /Hard silver overlay laminated to copper mobile contacts
Contact resistance – initial	30 mΩ max at 5 A
Contact resistance – end of life	60 mΩ max at 5 A

\* With P option less than 70 ms



# CK relay

## Technical specifications

### Contact design

#### Weld no transfer function:

If one NO contact welds, no NC contact can close (and vice versa) and cause an overlapping of functions.

A type test is realized to insure the relays meet this important safety requirement.

150% of max. operating voltage is applied to the relay while holding 1 NC contact closed by mechanical means.

Under these conditions, it is verified that no NO contact makes.

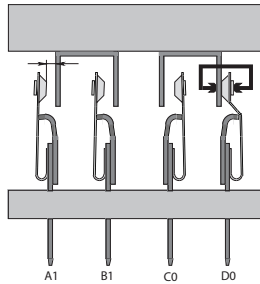

#### Double break contacts

Extend the contact life on highly inductive DC currents.

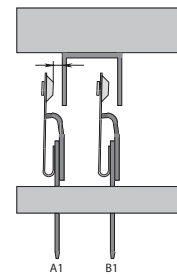

# CK relay

## Technical specifications

### Electrical characteristics

Dielectric strength	2200 VAC, 1 min between contacts, 2600 VAC, 1 min between contacts, coil and frame
Insulation resistance	≥ 1000 MΩ at 500 VDC

### Environmental & mechanical characteristics

Operating temperature	- 40°C to + 80°C
Operating position	May be mounted in any attitude, however, we recommend the following: if relay is mounted vertically, the direction of contact closure should be oriented transverse to the direction of forward motion. If relay is mounted horizontally, it should be oriented so that gravity will cause the contacts to revert to their de-energized position.
Contact life (mechanical)	100 million cycles.
Weight	Relay: 400 grams (14.1 ounces)
Vibration	Tests are conducted in the X, Y, Z planes at resonant frequency between 5 & 50 cycles at 1 g, or if indeterminate at 10 Hz (sinusoidal).
Shock	Tests are applied in both directions in the X, Y & Z planes. Three successive shocks are administered consisted of the positive component of sinusoidal with a value of 30 g, 11 milliseconds.
Humidity	93% RH, 40°C for 4 days.
Salt mist	5% NaCl, 35°C for 4 days
Protection degree	IP40 (relay on socket)
Insulation terminals	Polycarbonate Resin (cover) / Phenolic Compound (base)
Fire and smoke	NF F16-101/102, fire and smoke material selection and application for electrical equipment.



# CK relay

## Technical specifications

### Dimensions (mm)

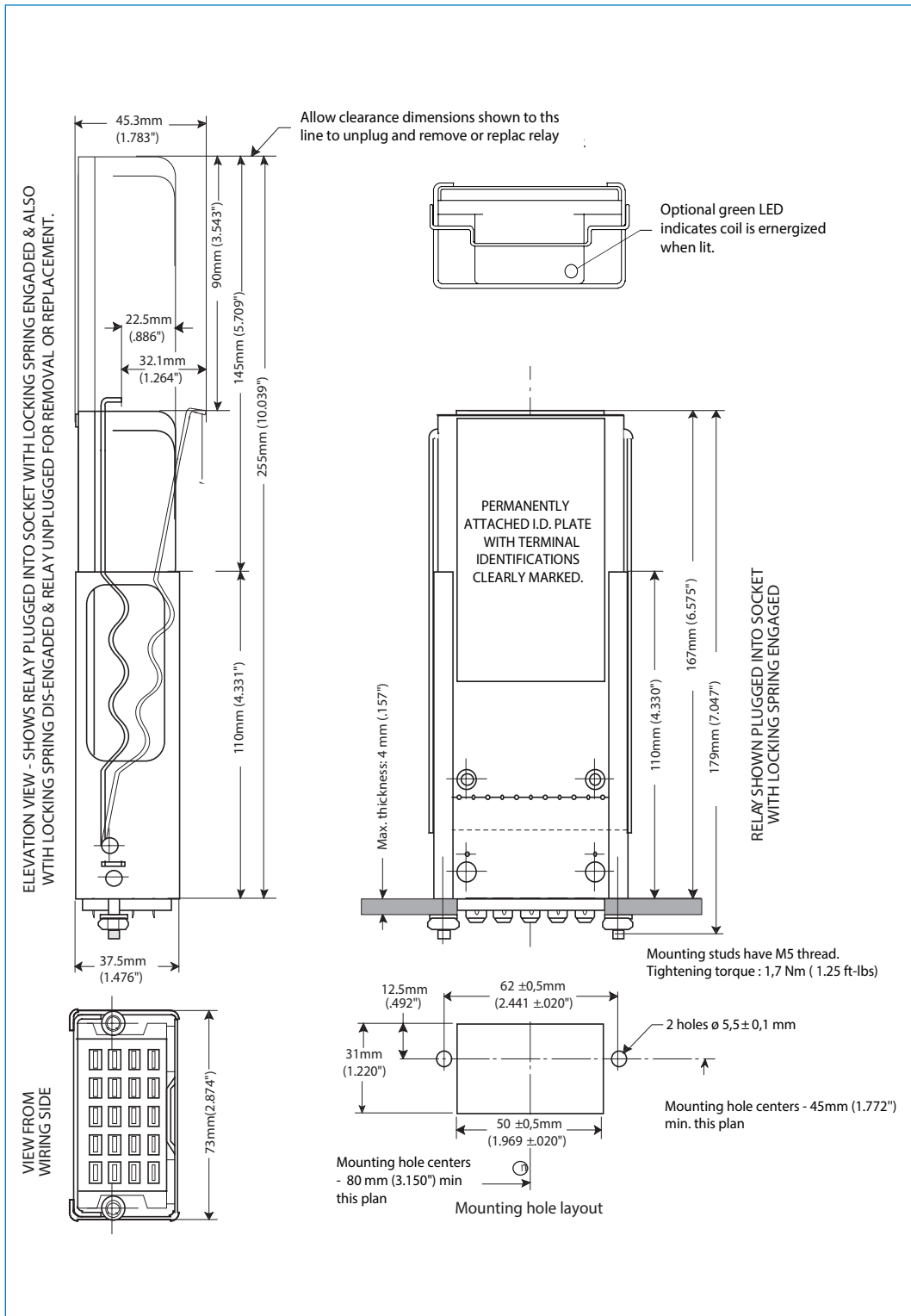

# CK relay

## Technical specifications

### Dynamic relay selection curve - No. 1

AC Current breaking capacity versus life expectancy in millions of cycles.

Rate of contacts opening and closing = 1200 operations per hour.

Curves shown for resistive (Power factor = 1)

Curves	1	2	3	4
VAC	220	125	48	24

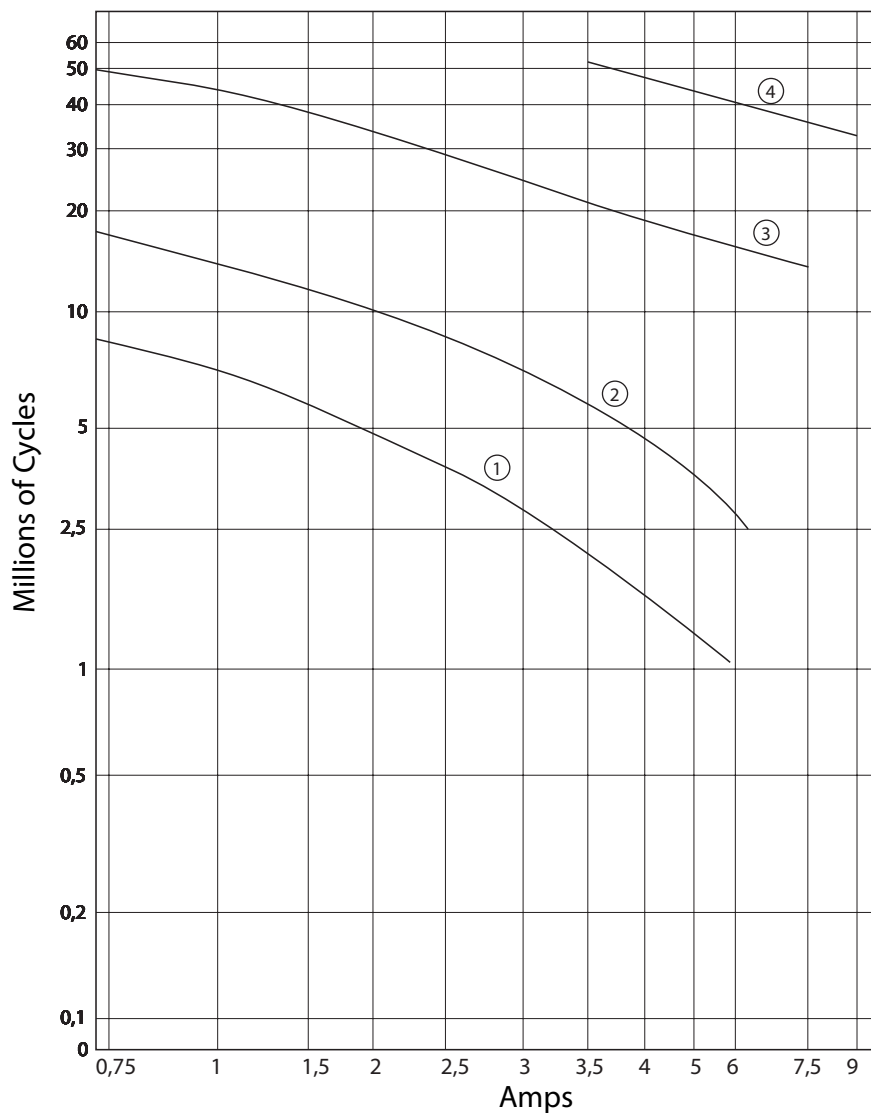

# CK relay

## Technical specifications

### Dynamic relay selection curve - No. 2

**DC Current breaking capacity versus life expectancy in millions of cycles.**

Rate of contacts opening and closing = 1200 operations per hour.

Curves shown for inductive load -

— L/R = 20 ms continuous current

- - - - L/R = 40 ms continuous current

Curves	1-3	2-4	5-7	6-8
VDC	220	125	48	24

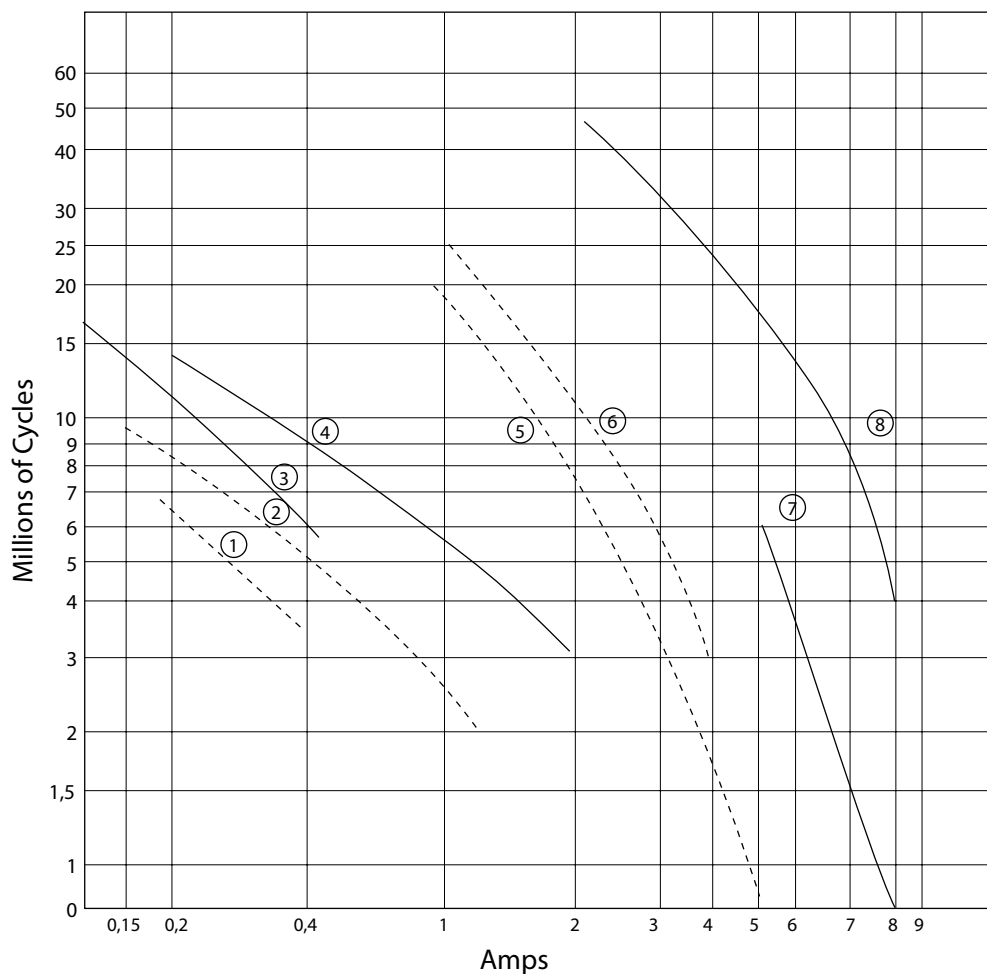



# CK relay

## Technical specifications

### Dynamic relay selection curve - No. 3

**DC Current breaking capacity versus life expectancy in millions of cycles.**

Rate of contacts opening and closing = 1200 operations per hour.

Curves shown for resistive load ( $L/R = 0$ ). Continuous current.

Curves	1	2	3	4
VDC	220	125	48	24

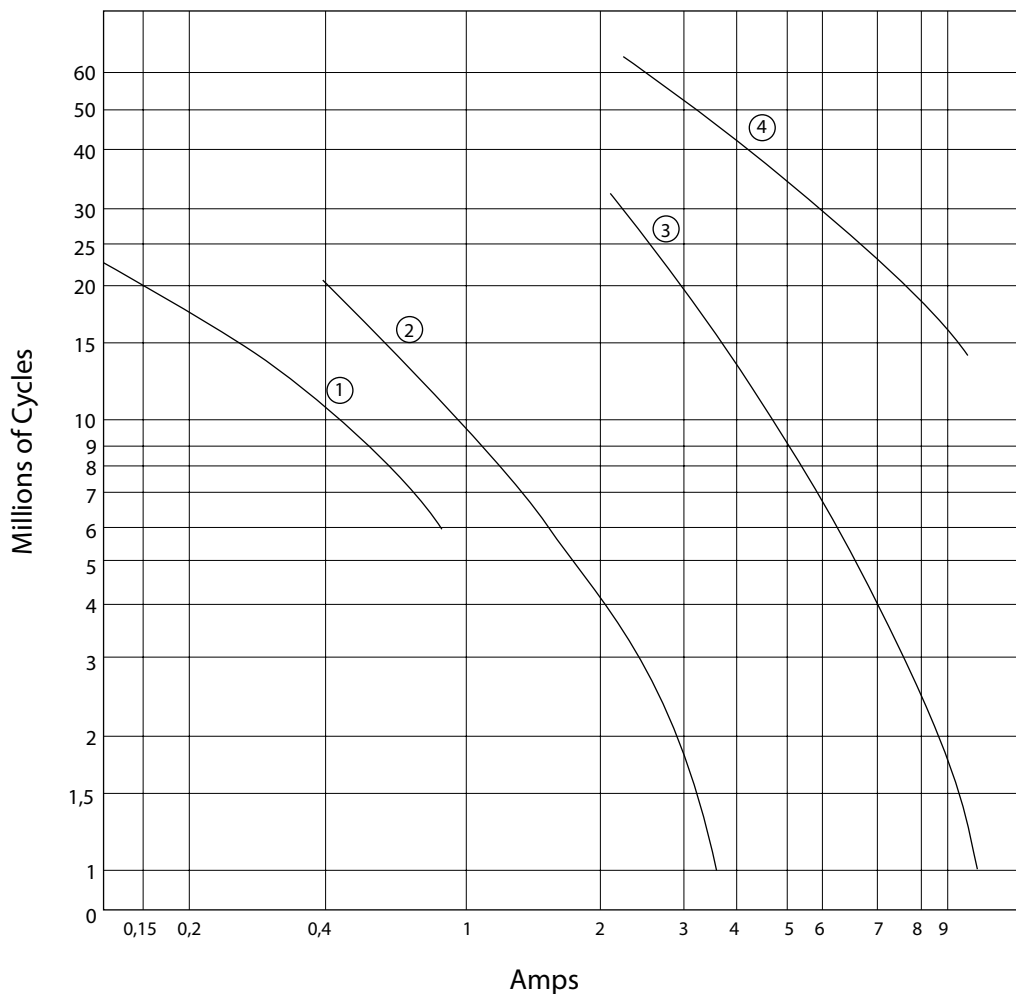

# CK relay

## Technical specifications

### Dynamic relay selection curve - No. 4

#### Maximum contact breaking capacity versus voltage for a given L/R

Rate of contacts opening and closing = 600 operations per hour.

Curves shown for resistive load (L/R = 0) and inductive loads. Continuous current.

Life expectancy: 800,00 cycles

Curves	1	2	3	4	5	6
L/R=	0ms	15ms	20ms	40ms	60ms	100ms

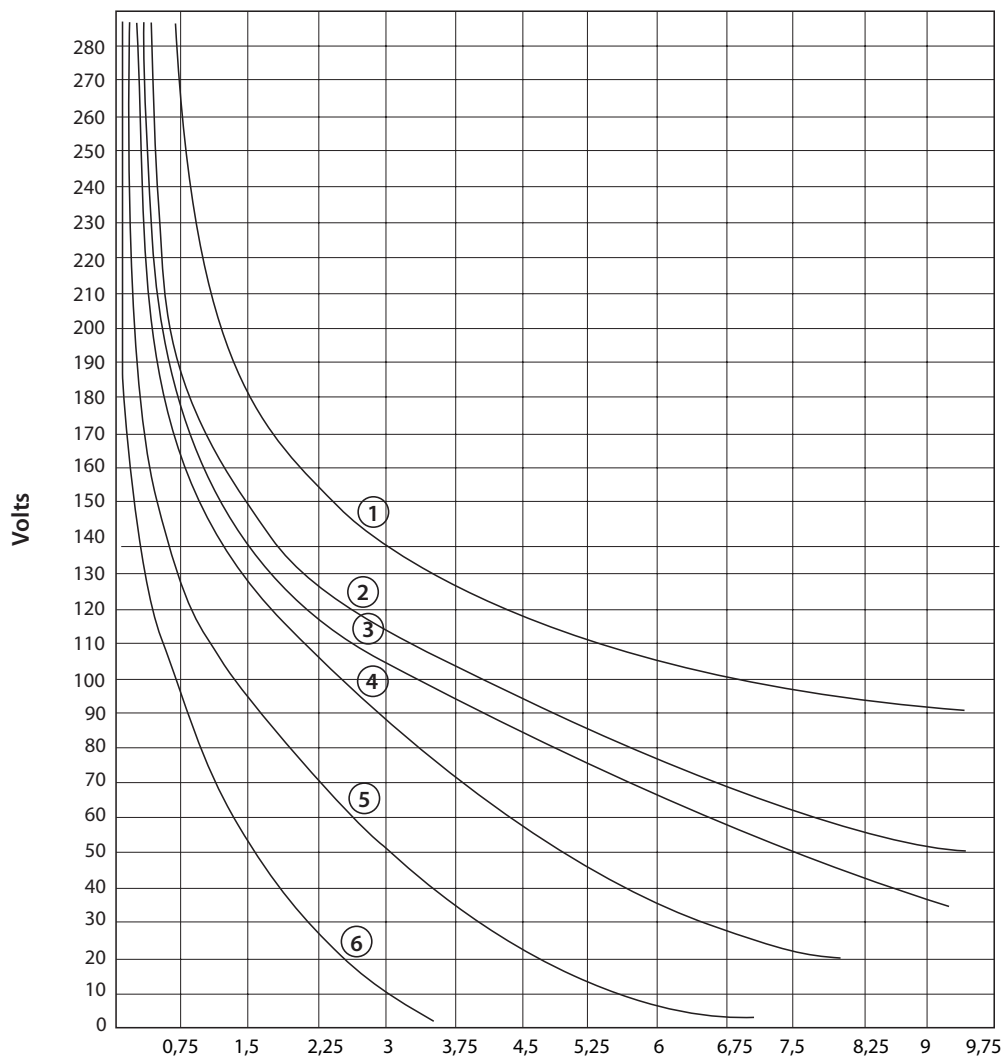

# CK relay

## Technical specifications

### Dynamic relay selection curve No 5

AC current breaking capacity versus life expectancy in millions of cycles.

Rate of contacts opening and closing = 1200 operations per hour.

Values shown for inductive loads:

———  $\cos \phi = 0.7$   
 - - -  $\cos \phi = 0.5$   
 - - -  $\cos \phi = 0.3$

Curves	1,3 & 5	2, 4 & 6	6, 9 & 10	8, 11 & 12
VAC	220	125	48	24

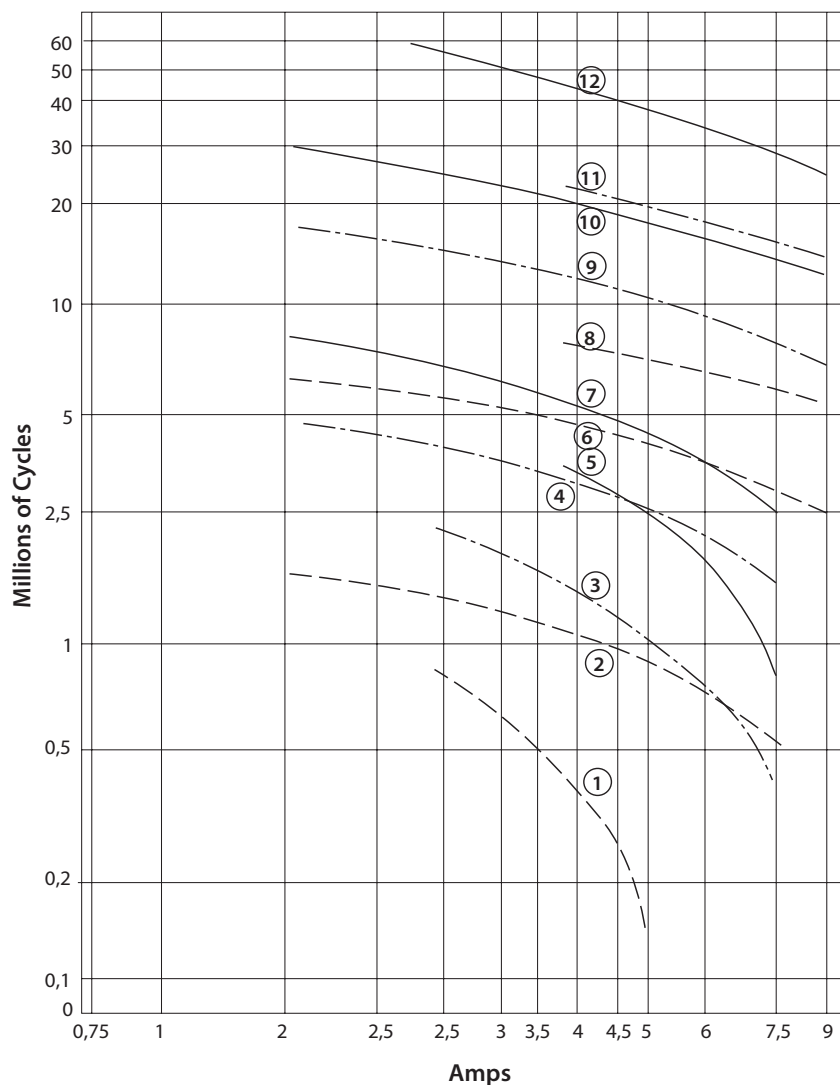

# CK relay

## Mounting possibilities

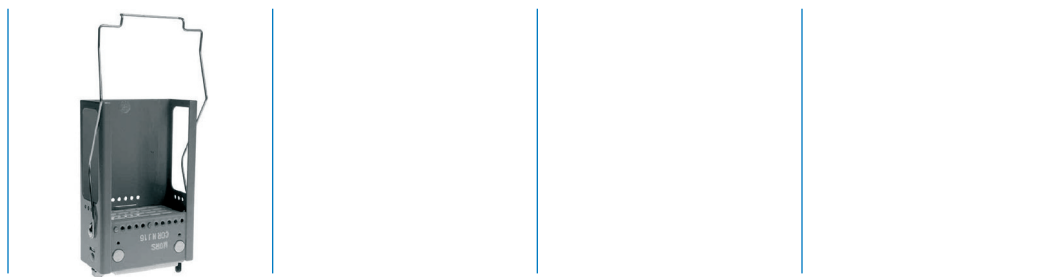

COR NJ

## Mounting possibilities/sockets

### Panel mounting

153879	COR NJ X*	Socket (Alkyde Compound) with locking spring (weight: 200 grams)
--------	-----------	--

*\*X indicates keying code from relay table*



# CK relay

## Technical specifications

### Mechanical keying of relay & socket

Mechanical keying of the relay to the socket is accomplished during manufacture.

Keying slots are located by their keying code numbers on the relay board. Keying rivets are located in the steel socket frame in the correct (and corresponding) coded rivet holes to mate with the relay.

Once keying has been completed during manufacture, it is permanent and cannot be changed. This is intentional in the design to insure that only the correct relay can be plugged into the socket.

The keying is completed by a color code on the top of the relay cover and on the side of the socket for better identification on the train.

The keying details are illustrated below.

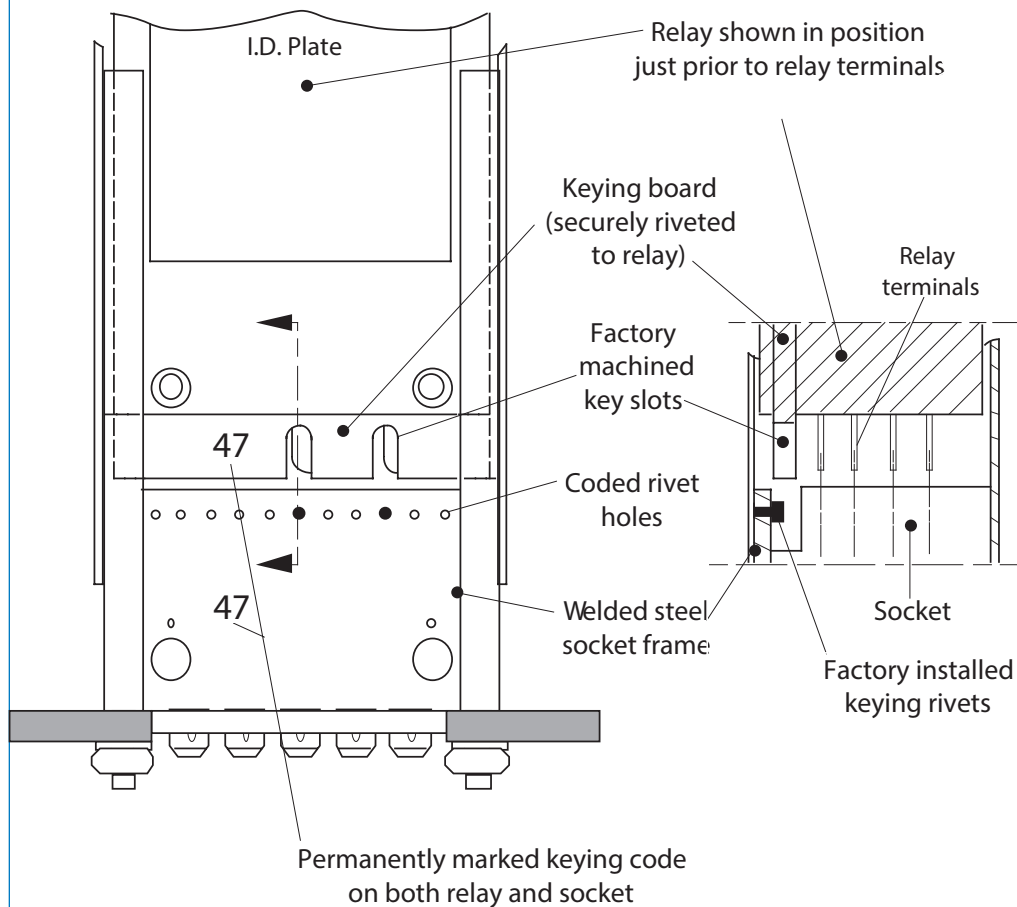

# CK relay

## User specifications

### Installation

Install socket and connect wiring correctly according identification to terminals. Plug relay into socket. Reverse installation into socket not possible due to mechanical blocking by locking spring bracket.  
Don't reverse polarity of coil connection. Relays can be mounted tightly next to each other.  
Warning! Never use silicon spray near by relays

### Operation

Before operating always apply voltage to coil to check correct operation.  
Long term storage may corrode the silver on the relay pins. Just by plugging the relay into the socket, the female bifurcated receivers will automatically clean the corrosion on the pins and guarantee a good connection.  
Do not use the relay in places with flammable gas as the arc generated from switching could ignite gasses.

### Maintenance

Correct operation of relay can easily be checked as transparent cover gives good visibility on the moving contacts. When the relay doesn't seem to operate correctly, please check presence of coil voltage. Use a multimeter. If LED is used, coil presence should be indicated. If coil voltage is present, but the relay doesn't work, a short circuit of a suppression diode is possible (The coil connection may-be reversed). If relay doesn't work after inspection, please replace relay unit by a similar model. Send defective relay back to manufacturer. Normal wear and tear excluded.



# CK relay

## Ordering scheme

CK

1. Relay model

027 24 47

2. Basic part number

S

3. Coil  
OVP

V

4. LED  
indicator

This example represents a CK 027 24 47 S V.

Description: CK series relay, Contact configuration: 2NC + 7NO, Unom 24 VDC, Keying 47, Transil coil protection, LED indicator

### 1. Relay model

CK

### 2. Relay basic part number\*

027 24 47	2 NC+7 NO	24 VDC	Sch.#1
027 36 16	2 NC+7 NO	36 VDC	Sch.#1
027 48 89	2 NC+7 NO	48 VDC	Sch.#1
027 72 11B	2 NC+7 NO	72 VDC	Sch.#1
027 110 4F	2 NC+7 NO	110 VDC	Sch.#1
027 220 1011	2 NC+7 NO	220 VAC	Sch.#1
045 24 45	4 NC+5 NO	24 VDC	Sch.#2
045 36 35	4 NC+5 NO	36VDC	Sch.#2
045 48 19	4 NC+5 NO	48 VDC	Sch.#2
045 72 69	4 NC+5 NO	72 VDC	Sch.#2
045 110 38	4 NC+5 NO	110 VDC	Sch.#2
045 220 4C	4 NC+5 NO	220 VAC	Sch.#2
009 24 3D	0 NC+9 NO	24 VDC	Sch.#3
009 36 46	0 NC+9 NO	36 VDC	Sch.#3
009 48 6C	0 NC+9 NO	48 VDC	Sch.#3
009 72 15	0 NC+9 NO	72 VDC	Sch.#3
009 110 1J	0 NC+9 NO	110 VDC	Sch.#3
009 220 5C	0 NC+9 NO	220 VAC	Sch.#3
054 24 49	5 NC+4 NO	24 VDC	Sch.#4
054 36 48	5 NC+4 NO	36 VDC	Sch.#4
054 48 711	5 NC+4 NO	48 VDC	Sch.#4
054 72 8D	5 NC+4 NO	72 VDC	Sch.#4
054 110 14	5 NC+4 NO	110 VDC	Sch.#4
054 220 611	5 NC+4 NO	220 VAC	Sch.#4
036 24 811	3 NC+6 NO	24 VDC	Sch.#5
036 48 410	3 NC+6 NO	48 VDC	Sch.#5
036 72 2E	3 NC+6 NO	72 VDC	Sch.#5
036 220 4E	3 NC+6 NO	220 VAC	Sch.#5
072 24 68	7 NC+2 NO	24 VDC	Sch.#6
072 36 511	7 NC+2 NO	36 VDC	Sch.#6
072 72 1F	7 NC+2 NO	72 VDC	Sch.#6
072 110 7F	7 NC+2 NO	110 VDC	Sch.#6

### 3. Coil overvoltage protection

–	No coil protection
S	Transil coil protection
P	Avalanche diode coil protection

### 4. LED coil voltage indicator

–	No LED
V	LED voltage indicator

### \* Description

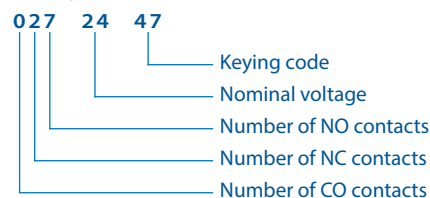

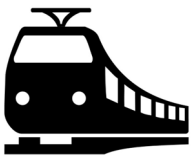

**Mors Smitt France SAS**

Tour Rosny 2, Avenue du Général de Gaulle,  
F - 93118 Rosny-sous-Bois Cedex, FRANCE  
T +33 (0)1 4812 1440, F +33 (0)1 4855 9001  
E [sales.msf@wabtec.com](mailto:sales.msf@wabtec.com)

**Mors Smitt Asia Ltd.**

29/E, Fun Towers, 35 Hung To Road  
Kwun Tong, Kowloon, HONG KONG SAR  
T +852 2343 5555, F +852 2343 6555  
E [sales.msa@wabtec.com](mailto:sales.msa@wabtec.com)

**Mors Smitt B.V.**

Vrieslantlaan 6, 3526 AA Utrecht,  
NETHERLANDS  
T +31 (0)30 288 1311, F +31 (0)30 289 8816  
E [sales.msbv@wabtec.com](mailto:sales.msbv@wabtec.com)

**Mors Smitt Technologies Inc.**

1010 Johnson Drive,  
Buffalo Grove, IL 60089-6918, USA  
T +1 847 777 6497, F +1 847 520 2222  
E [salesmst@wabtec.com](mailto:salesmst@wabtec.com)

**Mors Smitt UK Ltd.**

Graycar Business Park, Barton under Needwood,  
Burton on Trent, Staffordshire, DE13 8EN, UK  
T +44 (0)1283 722650 F +44 (0)1283 722651  
E [sales.msuk@wabtec.com](mailto:sales.msuk@wabtec.com)

**RMS Mors Smitt**

6 Anzed Court, Mulgrave,  
VIC 3170, AUSTRALIA  
T +61 (0)3 8544 1200 F +61 (0)3 8544 1201  
E [sales.rms@wabtec.com](mailto:sales.rms@wabtec.com)