

CG relay - Safety critical, 9 contacts, gold plated

Datasheet

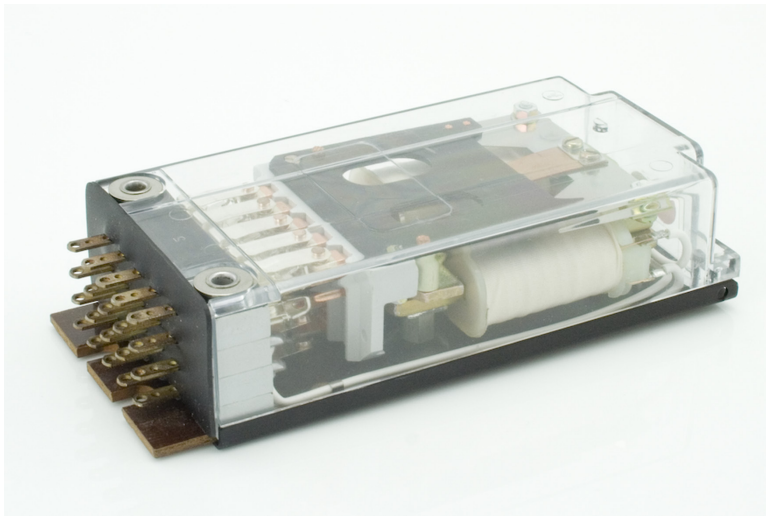

Description

The CG relay is an instantaneous and safety critical relay equipped with 9 double break contacts (Form X & Y - per customers specification) in all N/O and N/C combinations, gold plated. The plug-in design offers secure locking feature for maximum ease of maintenance (no wires need to be disconnected or other hardware removed for relay inspection or replacement).

The resistance to impact and vibration is conforming the standards for Railway Transported Equipment. Positive mechanical keying of relay to socket is built into relay and socket during manufacturing and terminal identifications are clearly marked on identification plate that is permanently attached to the relay.

The CG relays is pluggable in the COR NJ socket.

Application

The CG relay is designed to offer ultra-compact space saving size for safety critical applications such as door control, emergency brake failure, interlocking between traction and breaking, around the world in countless railcars.

Features

- Instantaneous relay
- Ultra compact package size
- Safety critical relay
- Plug-in design with secure locking feature for maximum ease of maintenance
- 9 double break contacts in all N/O and N/C combinations
- Weld no transfer safety contacts standard
- Contact life (mechanical) of 100 million cycles
- -40°C...+80°C operating temperature

Benefits

- Proven reliable in heavy duty application
- Space Saving package size
- Long life cycle cost
- Easy to maintain and replace
- Used in safety critical application
- Low life cycle cost

Railway compliancy

- NF F 62-002 Rolling stock - Instantaneous relays contacts and sockets
- NF F 16-101/102 Fire behaviour - Railway rolling stock



CG relay

Technical specifications

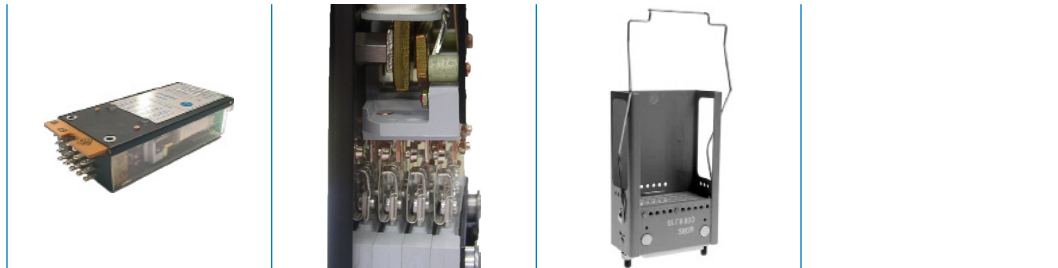

Functional and connection diagrams

Timing diagram	Relay pin correspondence																														
	<p>Keying Plate</p> <table border="1"> <thead> <tr> <th></th> <th>0</th> <th>1</th> <th>2</th> <th>3</th> <th>4</th> </tr> </thead> <tbody> <tr> <td>A</td> <td>—</td> <td>—</td> <td>—</td> <td>—</td> <td>—</td> </tr> <tr> <td>B</td> <td>—</td> <td>—</td> <td>—</td> <td>—</td> <td>—</td> </tr> <tr> <td>C</td> <td>—</td> <td>—</td> <td>—</td> <td>—</td> <td>—</td> </tr> <tr> <td>D</td> <td>—</td> <td>—</td> <td>—</td> <td>—</td> <td>—</td> </tr> </tbody> </table> <p>Relay pin correspondence (rear view of relay shown)</p>		0	1	2	3	4	A	—	—	—	—	—	B	—	—	—	—	—	C	—	—	—	—	—	D	—	—	—	—	—
	0	1	2	3	4																										
A	—	—	—	—	—																										
B	—	—	—	—	—																										
C	—	—	—	—	—																										
D	—	—	—	—	—																										
Connection diagram																															
<table border="0"> <tr> <td style="text-align: center;"> <p>Schematic #1</p> </td> <td style="text-align: center;"> <p>Schematic #2</p> </td> <td style="text-align: center;"> <p>Schematic #3</p> </td> </tr> <tr> <td style="text-align: center;"> <p>Schematic #4</p> </td> <td style="text-align: center;"> <p>Schematic #5</p> </td> <td style="text-align: center;"> <p>Schematic #6</p> </td> </tr> </table>		<p>Schematic #1</p>	<p>Schematic #2</p>	<p>Schematic #3</p>	<p>Schematic #4</p>	<p>Schematic #5</p>	<p>Schematic #6</p>																								
<p>Schematic #1</p>	<p>Schematic #2</p>	<p>Schematic #3</p>																													
<p>Schematic #4</p>	<p>Schematic #5</p>	<p>Schematic #6</p>																													



CG relay

Technical specifications

Coil data - DC versions

U _{nom} (VDC)	U _{operating} (VDC)	P _{nom} (W)	U _{hold} (VDC)	U _{drop-out} (VDC)	R coil (Ω) ⁽¹⁾	L/R (ms) ⁽²⁾
24	16 / 33	4.8	13.5	2.5	120	25
36	25 / 45	4.8	21	3.5	270	25
48	33 / 60	4.6	28.5	4.5	500	25
72	48 / 90	5.2	40.5	6.5	1000	25
110	77 / 138	5	60	11.5	2400	25

(1) Coil resistance tol.: ± 8% at 20 °C

(2) Valid for closed relay.

Coil data - AC versions

U _{nom} (VAC)	U _{operating} (VAC)	P _{nom} (VA)	U _{hold} (VAC)	U _{drop-out} (VAC)	R coil (Ω) ⁽¹⁾	L/R (ms) ⁽²⁾
220	176 / 242	4	129	21	12000	25

(1) Coil resistance tol.: ± 8% at 20 °C

(2) Valid for closed relay.

Contact data – dry circuit application (gold contacts)

Contact design	Stationary contact	2 single contacts (contacts are in series)
	Movable contact	Solid blade
Maximum contact rating	Operating	20 mA max. at 72 VDC
	Carry only (no make and break)	5 A max. at 5 VDC
Minimum current rating		10 mA at 12 VDC
Number of contacts		9 double make / double break contacts (form X & Y)
Contact material	Stationary contact	Gold plated over hard silver
	Movable contact	Gold over hard silver overlay laminated to copper
Contact resistance		< 20 mΩ max at 5 A (Carry only)



CG relay

Technical specifications

Contact design

Weld no transfer function:

If one N/O contact welds, no N/C contact can close (and vice versa) and cause an overlapping of functions.

A type test is realized to insure the relays meet this important safety requirement.

150% of max. operating voltage is applied to the relay while holding 1 NC contact closed by mechanical means.

Under these conditions, it is verified that no N/O contact makes.

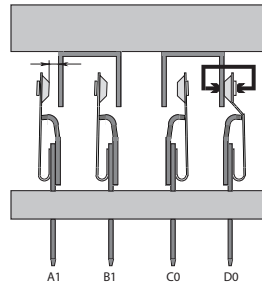

Double break contacts

Extend the contact life on highly inductive DC currents.

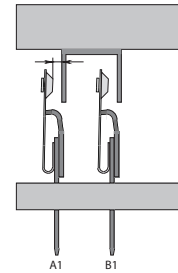

Electrical characteristics

Dielectric strength	2200 VAC, 1 min between contacts, 2600 VAC, 1 min between contacts, coil and frame
Insulation resistance	≥ 1000 MΩ at 500 VDC



CG relay

Technical specifications

Mechanical & environmental characteristics

Vibration	NF F 62-002 The tests are conducted in the X, Y , Z planes at frequency between 10 & 150 cycles (sinusoidal) at 2 g
Shock	NF F 62-002 Tests are applied in both directions in the X, Y & Z planes. Then successive shocks are administered consisting of the positive component of sinusoidal with a value of 30 g, 18 ms Other vibration and shock tests can be performed on request
Mechanical life	> 100 x 10 ⁶ operations
Weight	400 g
Temperature	-40 °C...+80 °C
Humidity	93% RH, 40° C for 4 days
Salt mist	5% NaCl, 35° C for 4 days
Protection	IP40 (relay on socket)
Fire & smoke	Materials: Polycarbonate resin (cover) / Phenalic compound (base) Note: These materials have been tested for fire propagation and smoke emission according to standards NF F 16-101, NF F 16-102, and have been approved to be used on the English/French train channel shuttle.



CG relay

Technical specifications

Dimensions (mm)

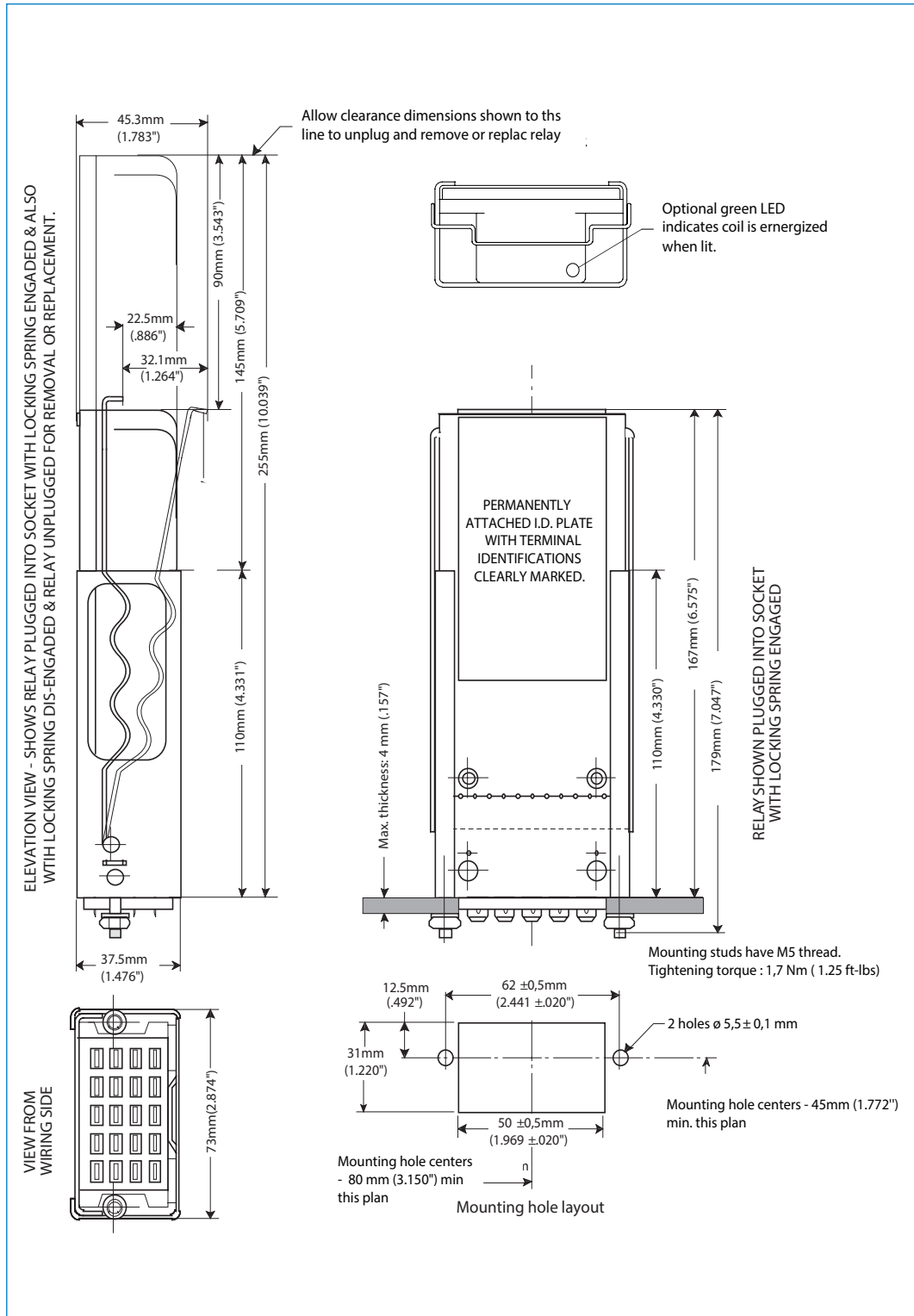

CG relay

Technical specifications

Dynamic relay selection curve - No. 1

AC Current breaking capacity versus life expectancy in millions of cycles.

Rate of contacts opening and closing = 1200 operations per hour.

Curves shown for resistive (Power factor = 1)

Curves	1	2	3	4
VAC	220	125	48	24

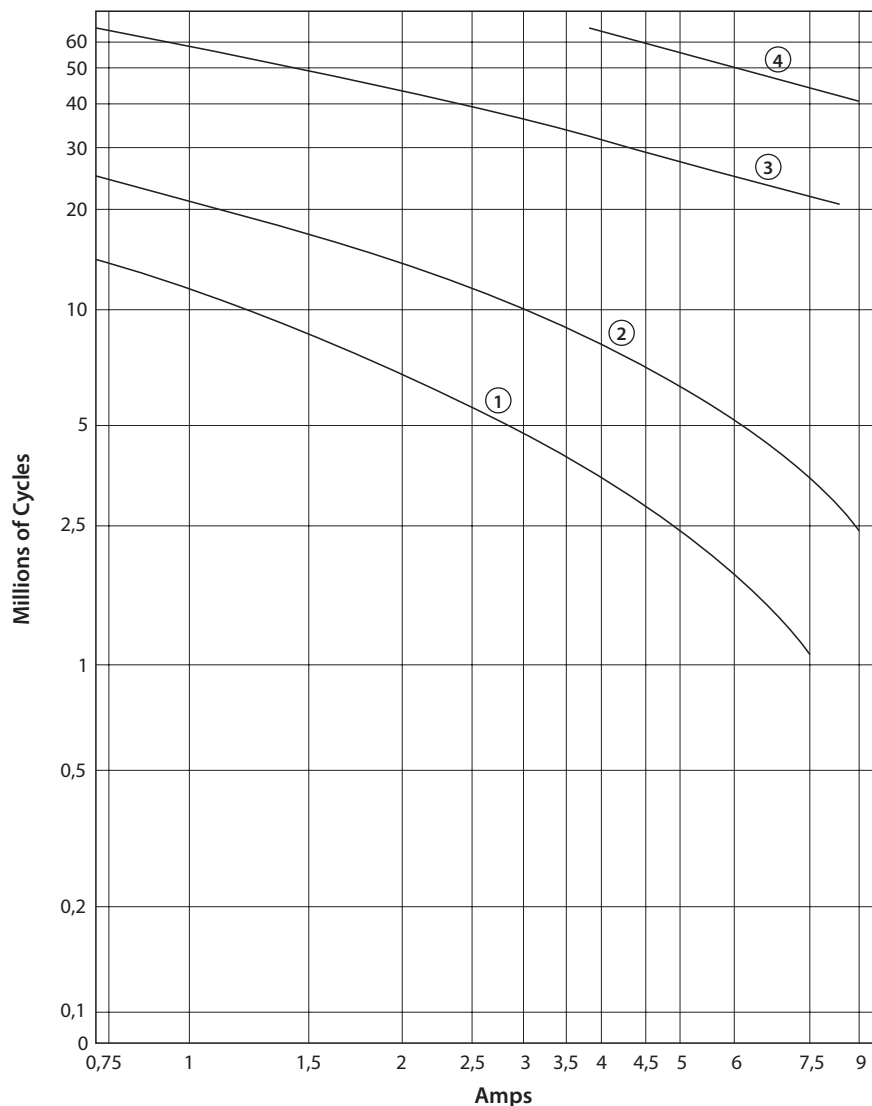

CG relay

Technical specifications

Dynamic relay selection curve - No. 2

DC Current breaking capacity versus life expectancy in millions of cycles.

Rate of contacts opening and closing = 1200 operations per hour.

Curves shown for inductive load -

— L/R = 20 ms continuous current

- - - L/R = 40 ms continuous current

Curves	1-3	2-4	5-7	6-8
VDC	220	125	48	24

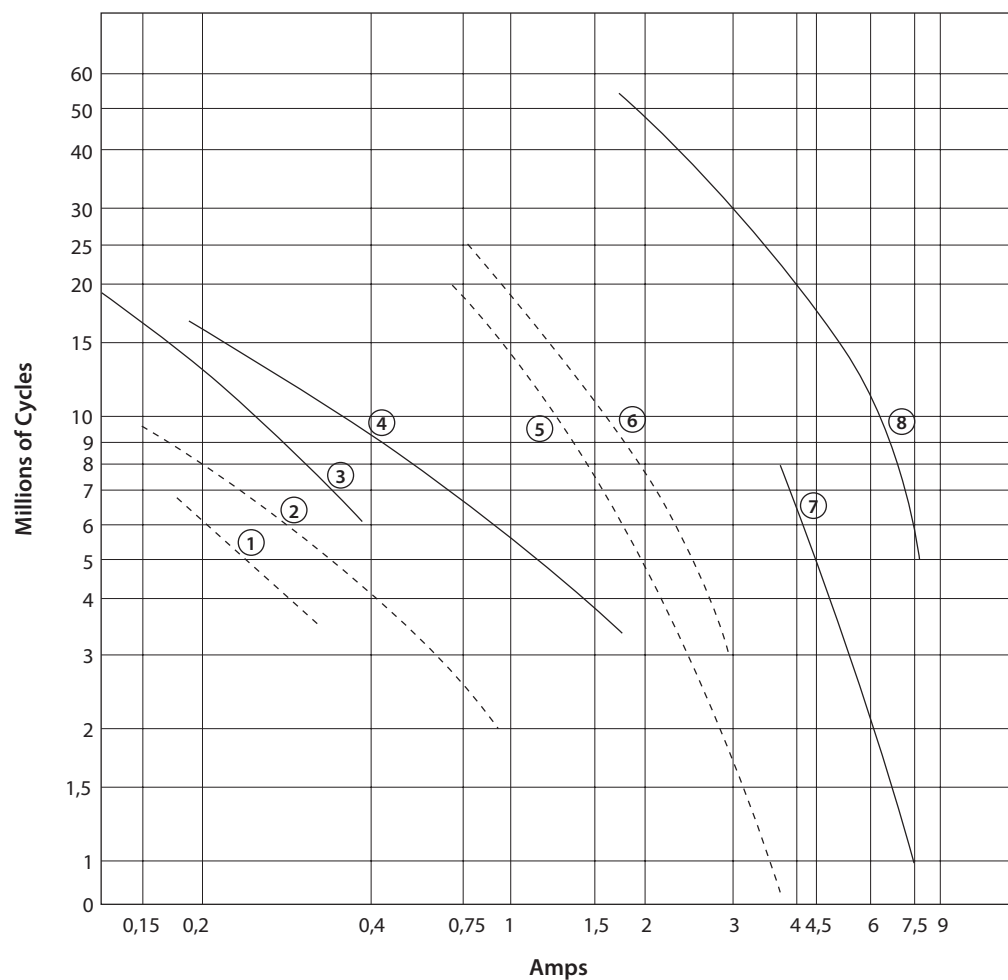

CG relay

Technical specifications

Dynamic relay selection curve - No. 3

DC Current breaking capacity versus life expectancy in millions of cycles.

Rate of contacts opening and closing = 1200 operations per hour.

Curves shown for resistive load ($L/R = 0$). Continuous current.

Curves	1	2	3	4
VDC	220	125	48	24

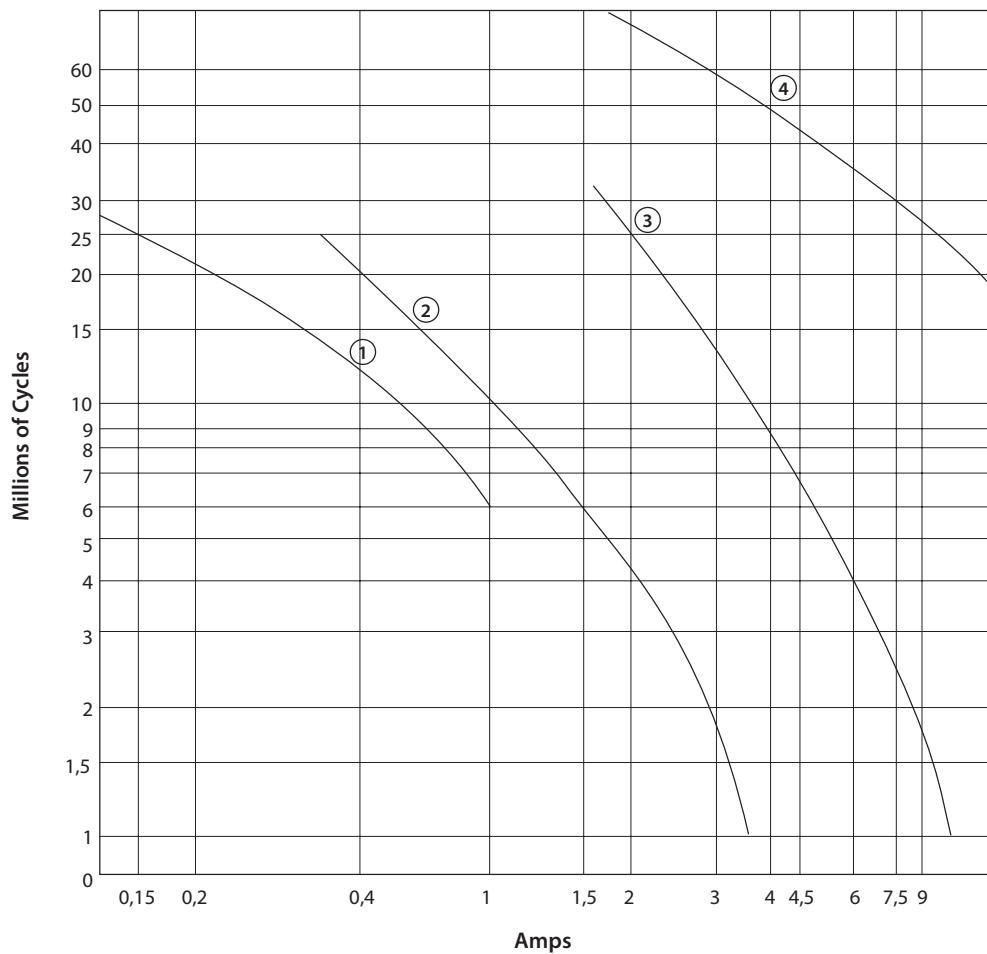

CG relay

Technical specifications

Dynamic relay selection curve - No. 4

Maximum contact breaking capacity versus voltage for a given L/R

Rate of contacts opening and closing = 600 operations per hour.

Curves shown for resistive load (L/R = 0) and inductive loads. Continuous current.

Curves	1	2	3	4	5	6
L/R=	0 ms	15 ms	20 ms	40 ms	60 ms	100 ms

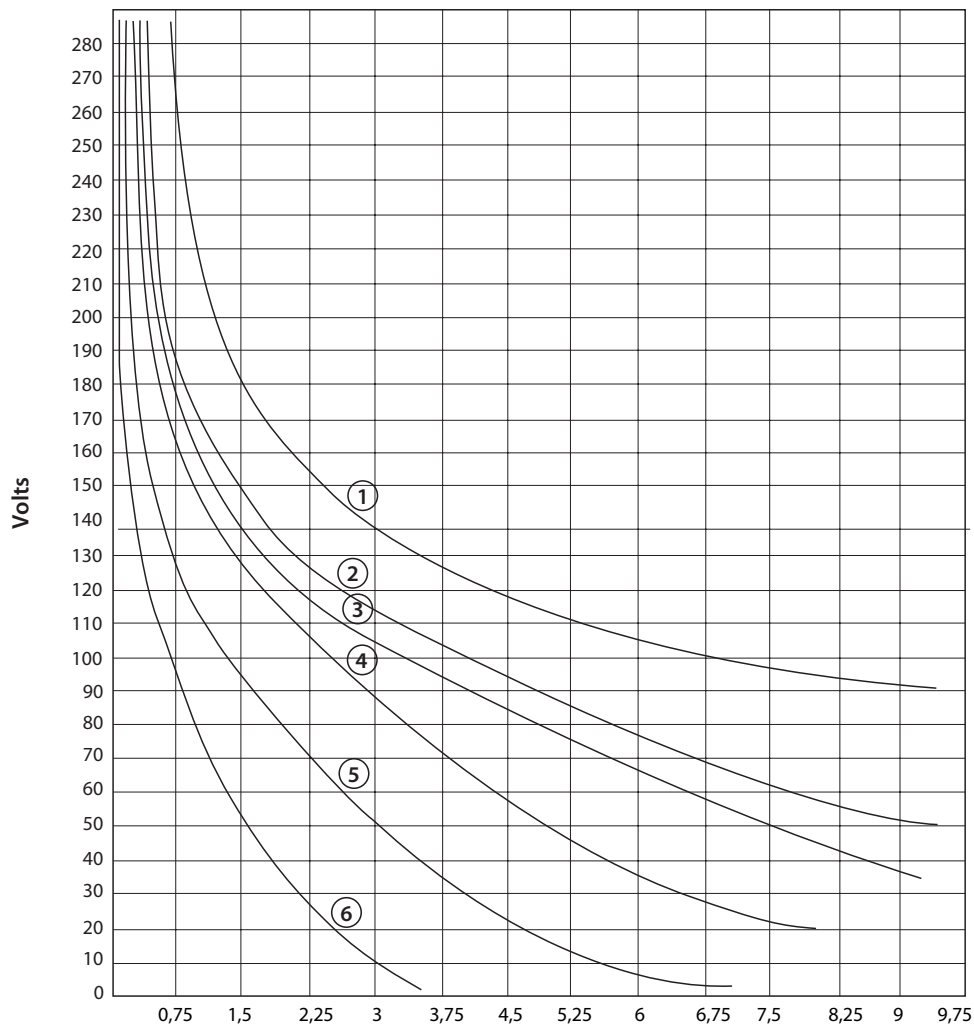

CG relay

Technical specifications

Dynamic relay selection curve - No. 6

AC current breaking capacity versus life expectancy in millions of cycles.

Rate of contacts opening and closing = 1200 operations per hour.

Values shown for inductive loads:

- Cos ϕ = 0.7
- - - Cos ϕ = 0.5
- - - - Cos ϕ = 0.3

Curves	1,3 & 5	2, 4 & 6	6, 9 & 10	8, 11 & 12
VAC	220	125	48	24

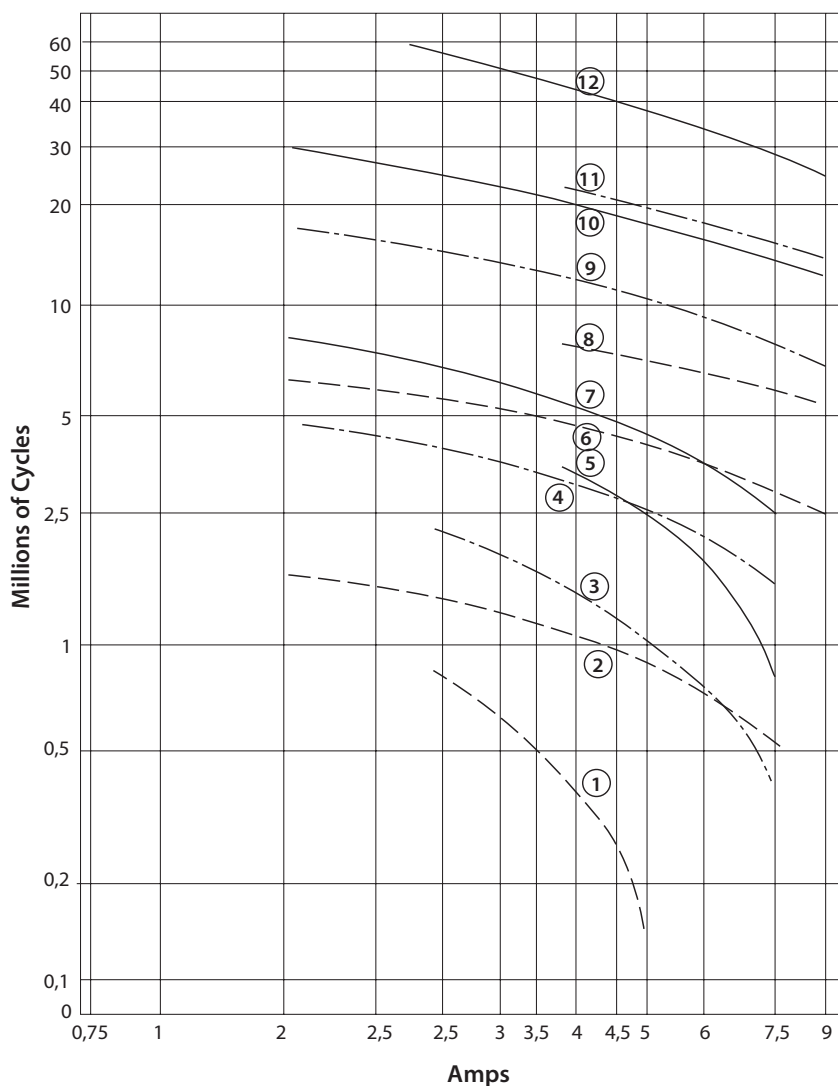

CG relay

Mounting possibilities

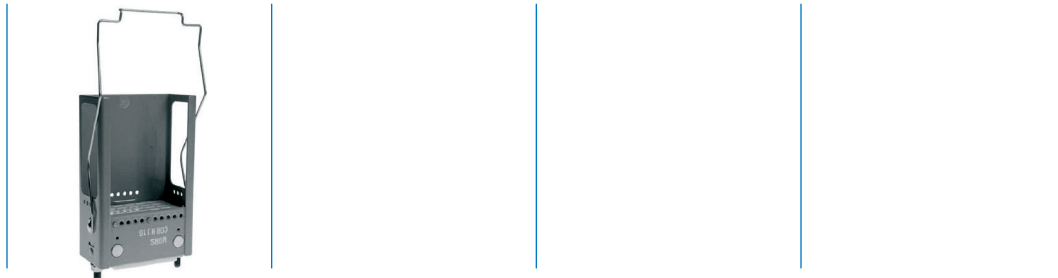

COR NJ

Mounting possibilities/sockets

Panel mounting

153879	COR NJ X*	Socket (alkyde compound) with locking spring
--------	-----------	--

**X indicates keying code from relay table*

CG relay Keying

Mechanical keying of relay & socket

Mechanical keying of the relay to the socket is accomplished in the factory.

Keying slots are located by their keying code numbers on the relay board. Keying rivets are located in the steel socket frame in the correct (and corresponding) coded rivet holes to mate with the relay.

Once keying has been completed during manufacturing, it is permanent and cannot be changed. This is intentional in the design to insure that only the correct relay can be plugged into the socket.

The keying is completed by a colorcode on the top of the relaycover and on the side of the socket for better identification on the train.

The keying details are illustrated below.

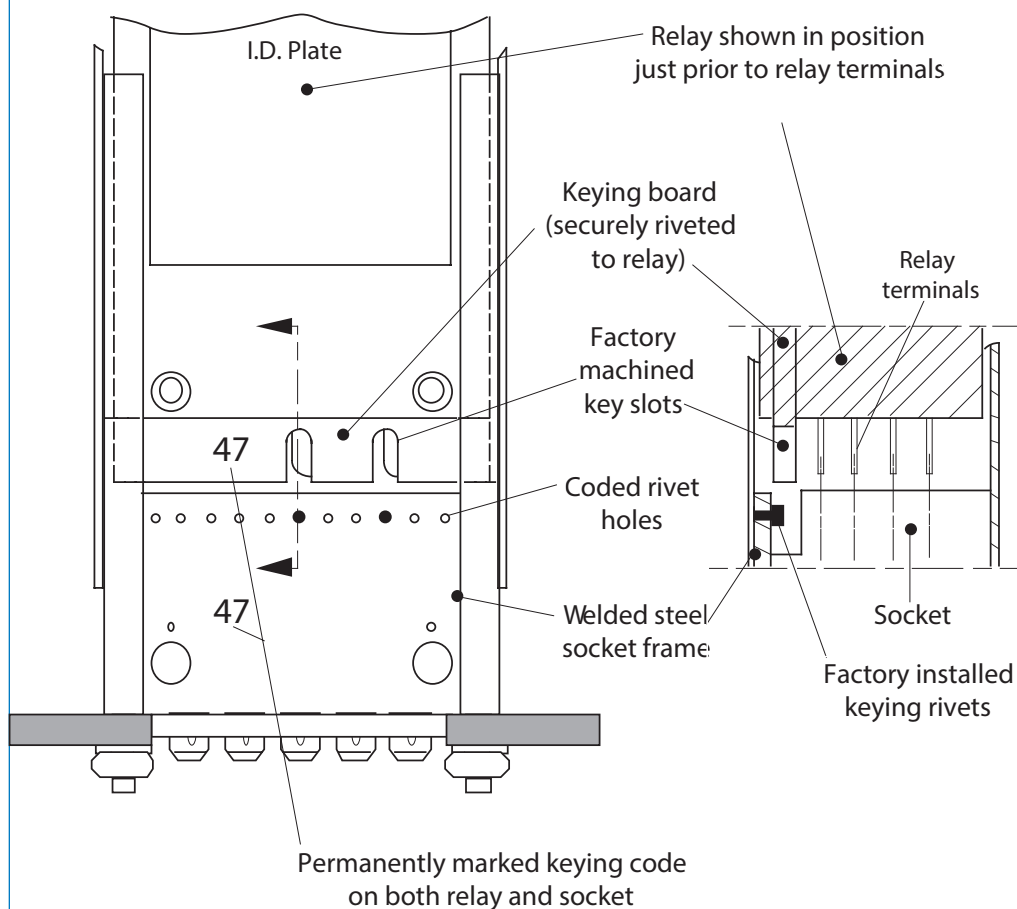

CG relay

User specifications

Installation

Install socket and connect wiring correctly according identification to terminals. Plug relay into socket. Reverse installation into socket not possible due to mechanical blocking by snap-lock.

Don't reverse polarity of coil connection.

Relays can be mounted (tightly) next to each other and in any attitude. However, we recommend the following:

- If the relay is mounted **vertical**; the direction of contact closure should be oriented transverse to the direction of forward motion.
- If the relay is mounted **horizontal**; the direction of contact closure should be oriented so that gravity will cause the contacts to revert to their de-energised position.

Warning! Never use silicon spray near by relays

Operation

Before operating always apply voltage to coil to check correct operation.

Long term storage may corrode the silver on the relay pins. Just by plugging the relay into the socket, the female bifurcated receivers will automatically clean the corrosion on the pins and guarantee a good connection.

Do not use the relay in places with flammable gas as the arc generated from switching could ignite gasses.

Maintenance

Correct operation of relay can easily be checked as transparent cover gives good visibility on the moving contacts. When the relay doesn't seem to operate correct, please check presence of coil voltage. Use a multimeter. If LED is used, coil presence should be indicated. If coil voltage is present, but the relay doesn't work, a short circuit of suppression diode is possible (The coil connection was reversed). If relay doesn't work after inspection, please replace relay unit by a similar model. Send defective relay back to manufacturer. Normal wear and tear excluded.



CG relay

Ordering scheme

CG

1. Relay model

027 24 47

2. Basic part number

S

3. Coil
OVP

V

5. LED
indicator

This example represents a CG 027 24 47 S V

Description: CG relay, contact configuration: 2 N/C + 7 N/O, U_{nom} 24 VDC, keying 47, transil coil protection, LED indicator

1. Relay model

CG

3. Coil overvoltage protection

– No coil protection
S Transil coil protection
P Avalanche diode coil protection

4. LED voltage indicator

– No LED
V LED voltage indicator

2. Relay basic part number*

027 24 47	2 N/C + 7 N/O	24 VDC	Sch. #1
027 36 16	2 N/C + 7 N/O	36 VDC	Sch. #1
027 48 89	2 N/C + 7 N/O	48 VDC	Sch. #1
027 72 11B	2 N/C + 7 N/O	72 VDC	Sch. #1
027 110 4F	2 N/C + 7 N/O	110 VDC	Sch. #1
027 220 1011	2 N/C + 7 N/O	220 VAC	Sch. #1
045 24 45	4 N/C + 5 N/O	24 VDC	Sch. #2
045 36 35	4 N/C + 5 N/O	36 VDC	Sch. #2
045 48 19	4 N/C + 5 N/O	48 VDC	Sch. #2
045 72 69	4 N/C + 5 N/O	72 VDC	Sch. #2
045 110 38	4 N/C + 5 N/O	110 VDC	Sch. #2
045 220 4C	4 N/C + 5 N/O	220 VAC	Sch. #2
009 24 3D	0 N/C + 9 N/O	24 VAC	Sch. #3
009 36 46	0 N/C + 9 N/O	36 VDC	Sch. #3
009 48 6C	0 N/C + 9 N/O	48 VDC	Sch. #3
009 72 15	0 N/C + 9 N/O	72 VDC	Sch. #3
009 110 1J	0 N/C + 9 N/O	110 VDC	Sch. #3
009 220 5C	0 N/C + 9 N/O	220 VAC	Sch. #3
054 24 49	5 N/C + 4 N/O	24 VDC	Sch. #4
054 36 48	5 N/C + 4 N/O	36 VDC	Sch. #4
054 48 711	5 N/C + 4 N/O	48 VDC	Sch. #4
054 72 8D	5 N/C + 4 N/O	72 VDC	Sch. #4
054 110 14	5 N/C + 4 N/O	110 VDC	Sch. #4
054 220 611	5 N/C + 4 N/O	220 VAC	Sch. #4
036 24 811	3 N/C + 6 N/O	24 VDC	Sch. #5
036 48 410	3 N/C + 6 N/O	48 VDC	Sch. #5
036 72 2E	3 N/C + 6 N/O	72 VDC	Sch. #5
036 220 4E	3 N/C + 6 N/O	220 VAC	Sch. #5
072 24 68	7 N/C + 2 N/O	24 VDC	Sch. #6
072 36 511	7 N/C + 2 N/O	36 VDC	Sch. #6
072 72 1F	7 N/C + 2 N/O	72 VDC	Sch. #6
072 110 7F	7 N/C + 2 N/O	110 VDC	Sch. #6

* Description

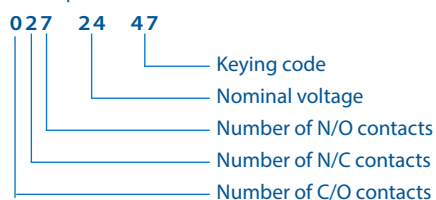

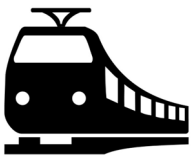

Mors Smitt France SAS

Tour Rosny 2, Avenue du Général de Gaulle,
F - 93118 Rosny-sous-Bois Cedex, FRANCE
T +33 (0)1 4812 1440, F +33 (0)1 4855 9001
E sales.msf@wabtec.com

Mors Smitt Asia Ltd.

29/F, Fun Towers, 35 Hung To Road
Kwun Tong, Kowloon, HONG KONG SAR
T +852 2343 5555, F +852 2343 6555
E sales.msa@wabtec.com

Mors Smitt B.V.

Vrieslantlaan 6, 3526 AA Utrecht,
NETHERLANDS
T +31 (0)30 288 1311, F +31 (0)30 289 8816
E sales.msbv@wabtec.com

Mors Smitt Technologies Inc.

1010 Johnson Drive,
Buffalo Grove, IL 60089-6918, USA
T +1 847 777 6497, F +1 847 520 2222
E salesmst@wabtec.com

Mors Smitt UK Ltd.

Graycar Business Park, Barton under Needwood,
Burton on Trent, Staffordshire, DE13 8EN, UK
T +44 (0)1283 722650 F +44 (0)1283 722651
E sales.msuk@wabtec.com

RMS Mors Smitt

6 Anzed Court, Mulgrave,
VIC 3170, AUSTRALIA
T +61 (0)3 8544 1200 F +61 (0)3 8544 1201
E sales.rms@wabtec.com